

NARDI
YOUR OUTDOOR LIVING

CON
TRA
-CT

contract
design Raffaello Galiotto

Arredi per l'outdoor
in resina fiber-glass studiati per il well-being delle persone.
Design, studio dei colori, eccellenza produttiva totalmente Made in Italy.
Attenzione all'ambiente nei cicli industriali, nella riciclabilità dei prodotti
e riutilizzo degli scarti, nell'ideazione di packaging eco-compatibili.
Ampia gamma di prodotti, misure e colori disponibili a catalogo
per arredi apprezzati dai progettisti di tutto il mondo.

*Outdoor furnishings
in fiberglass resin designed for people's well-being.
We bring together unique designs with the study of colours,
the manufacturing excellence of a product entirely created Made in Italy.
Great attention to the environment when it comes to the industrial cycles,
recycling products, reusing scraps and creating eco-compatible packaging.
A wide range of products, sizes and colours available in the furnishing catalogue
appreciated by project designers the world over.*

index

7	komodo
23	trill
31	net bench
37	net relax
41	net
49	bit
53	net stool
57	net table
61	bora · riva · costa
71	darsena · acquamarina
77	lido · faro
83	aria
91	palma · erica · gardenia · dalia
97	ninfea · loto
103	dama · regina · duca
109	cube
115	clip
121	step · spritz
125	frasca
131	fiore · ibisco
137	flute · break
141	scudo
145	atlantico · pop
153	alfa · omega
159	technical details

Komodo

SISTEMA MODULARE DI SEDUTE
MODULAR SYSTEM OF UPHOLSTERED SEATS

gardiente®
OUTDOOR
LIVING
AWARD
WINNER
2018
GOLD





KOMODO 5
tortora/rosa quarzo

KOMODO POUF
KOMODO ELEMENTO TERMINALE
tortora/rosa quarzo

KOMODO ELEMENTO CENTRALE
KOMODO ELEMENTO ANGOLO
tortora/rosa quarzo



KOMODO POLTRONA
tortora/rosa quarzo



KOMODO
tortora/rosa quarzo



KOMODO
agave/avocado



KOMODO
agave/avocado - giungla



KOMODO
bianco/ghiaccio - adriatic



KOMODO
bianco/adriatic



KOMODO
bianco/adriatic



KOMODO TAVOLINO
antracite



KOMODO TAVOLINO VETRO
antracite/vetro
KOMODO
antracite/grigio



KOMODO POUF
bianco/adriatic - tortora/ rosa quarzo - antracite/canvas - grigio



KOMODO POUF
bianco/canvas



KOMODO ECOWALL
terra



KOMODO ECOWALL
terra
KOMODO
agave/avocado

Trill

ARMCHAIR - BISTROT - STOOL





TRILL BISTROT
senape



TRILL BISTROT
ottanio



TRILL BISTROT
senape



TRILL ARMCHAIR
rosa bouquet
FRASCA MINI
bianco - piano Laminato 70x70 Total White



TRILL ARMCHAIR
rosa bouquet - grigio



TRILL STOOL - TRILL STOOL MINI
agave



TRILL STOOL
tabacco
FIORE HIGH
bianco



TRILL STOOL
agave

Net Bench





NET BENCH
senape
CUSCINO NET BENCH
denim



NET BENCH
antracite - senape
CUSCINO NET BENCH
grigio



NET BENCH
salice/the verde
NET TABLE 100
salice



NET BENCH - NET RELAX - NET TABLE 100
tortora
CUSCINI NET BENCH - NET RELAX - SHELL
denim

Net Relax



GOOD DESIGN AWARD 2018
winner



reddot award 2018
winner



selected by
ADI DESIGN INDEX 2017





NET RELAX
bianco - tortora
CUSCINO NET RELAX
rosa quarzo



NET RELAX
antracite
CUSCINI NET RELAX - SHELL
rosa quarzo



Net





NET
corallo - bianco - antracite
CUSCINO NET
rosa quarzo - bianco - grigio



NET
antracite



NET - FIORE
tortora



NET - SPRITZ
A Roma - Porec - Croatia



NET - SCUDO
Madliena Lodge - Swieqi - Malta



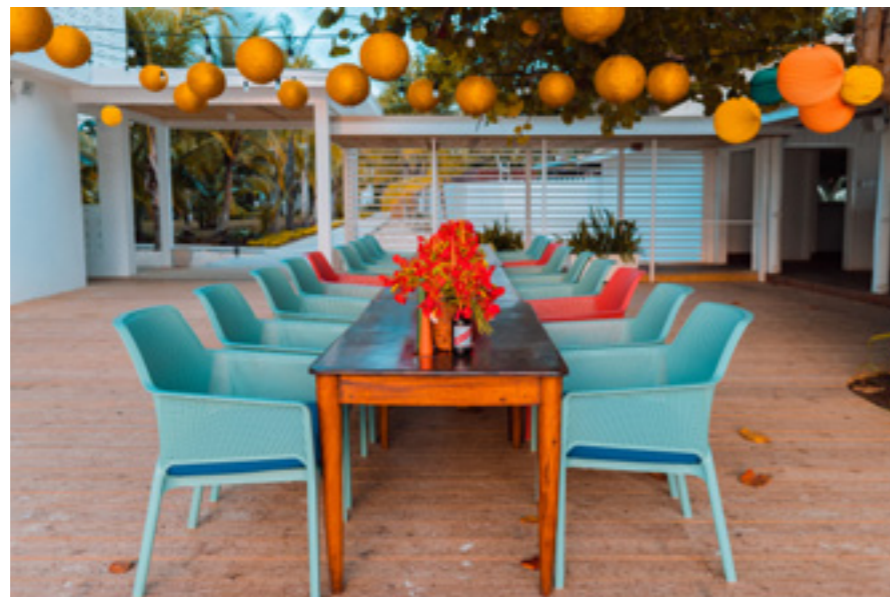

NET RELAX - SPRITZ
 Skylark Negril Beach Resort - Negril - Jamaica

NET RELAX
 Moncastro Hotel - Odessa - Ukraine

Bit





BIT - BREAK
antracite



BIT
salice

Net Stool





NET STOOL MINI - NET STOOL
tortora



NET STOOL
tortora



NET STOOL
senape

Net table

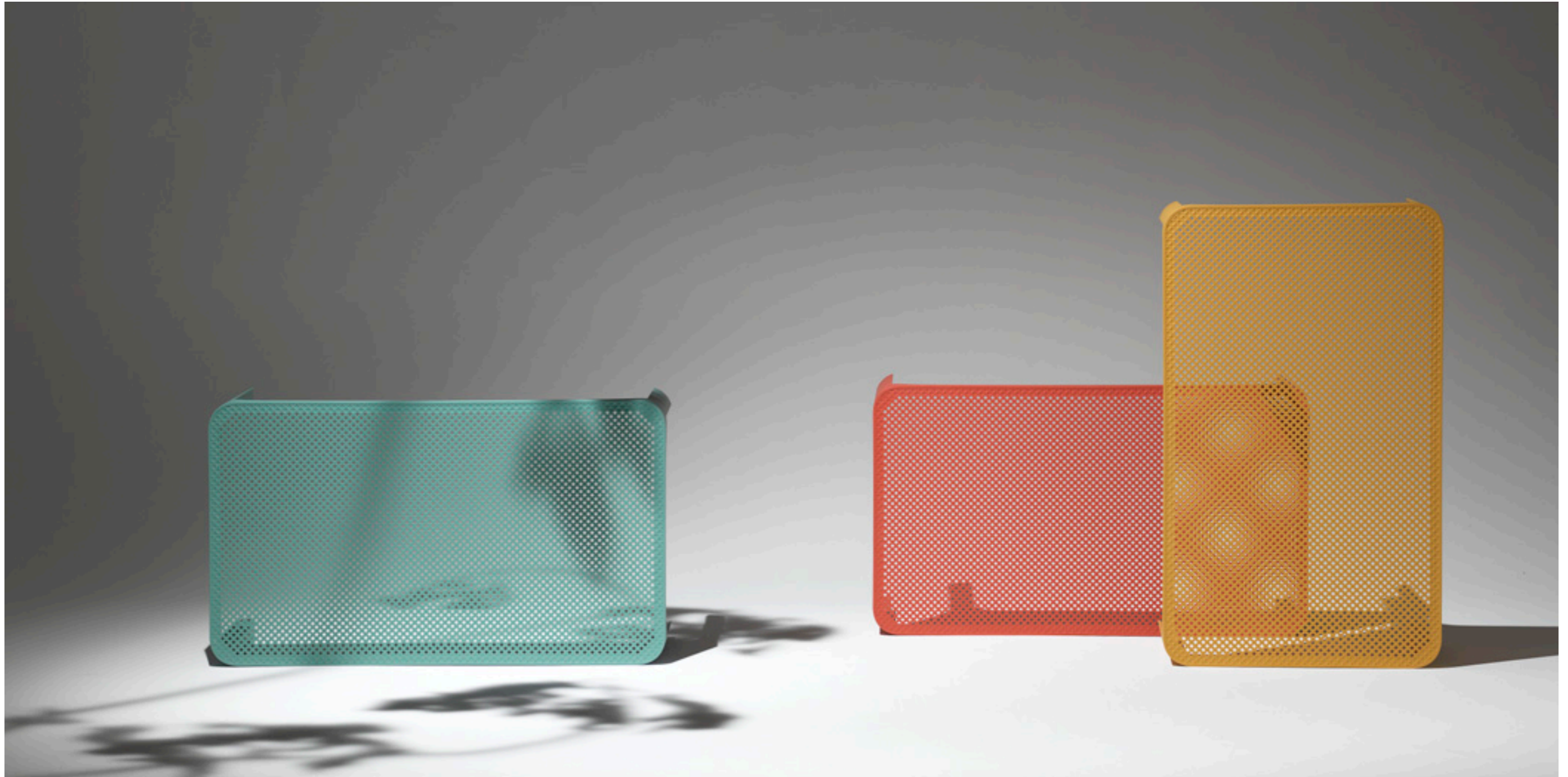



NET TABLE 100 - NET BENCH
bianco



NET TABLE 100
tortora



NET TABLE 100
antracite



Bora·Riva·Costa

ARMCHAIR - BISTROT





BORA
rosso



BORA - CLIP 70
tortora



BORA BISTROT
tortora



RIVA BISTROT - SPRITZ
agave



RIVA - FIORE
bianco





COSTA
bianco



COSTA
antracite



COSTA BISTROT
antracite



BORA BISTROT
Skylark Negril Beach Resort - Negril - Jamaica



COSTA
Vicenza - Italy



BORA - BORA BISTROT
Mulino Caffè - Vicenza - Italy



RIVA BISTROT
IAAD - Torino - Italy



FARO - COSTA BISTROT
Le Chicche - Vicenza - Italy

Darsena Acquamarina





DARSENA
antracite

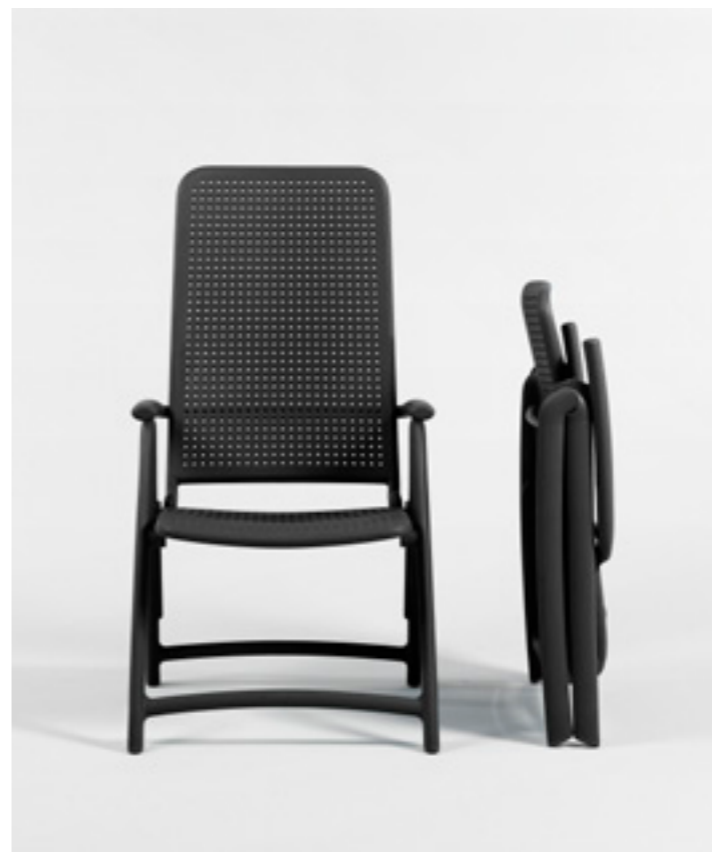

DARSENA
antracite





ACQUAMARINA
bianco
STEP
bianco



ACQUAMARINA
tortora

Lido·Faro





LIDO - LIDO MINI
tortora



LIDO
rosso



FARO
antracite



FARO
tortora
FIORE HIGH
bianco



FARO
antracite

Aria

POLTRONA - TAVOLINO

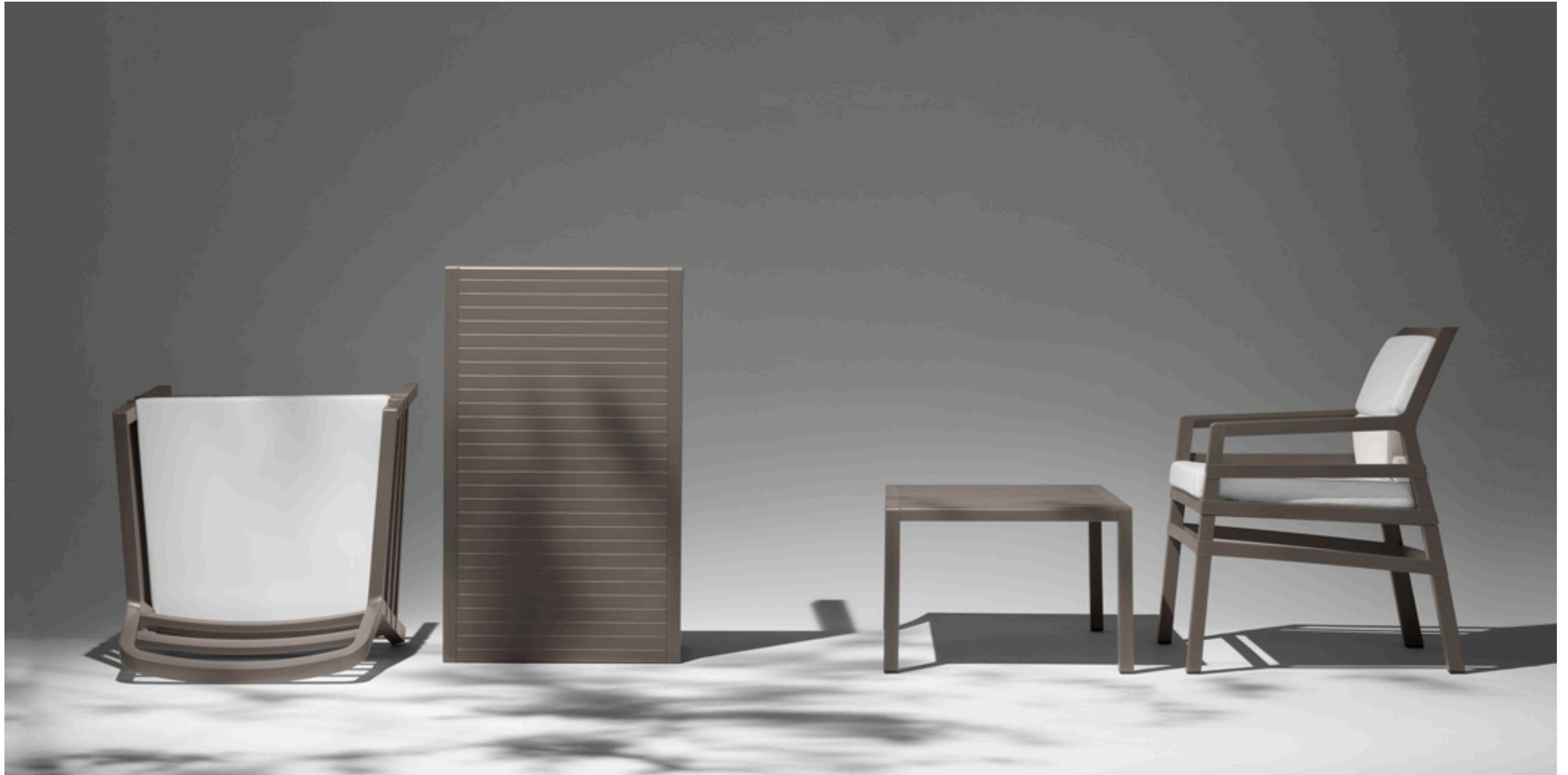



ARIA POLTRONA
bianco/sardinia



ARIA FIT
tortora/grigio
FIORE
tortora



ARIA FIT
tortora/bianco



ARIA POLTRONA
antracite/lime
ARIA TAVOLINO 60
antracite



ARIA POLTRONA
tortora/caffè
ARIA TAVOLINO 100
tortora



ARIA
Ammos Beach Bar
Kos - Greece



ARIA
Maris Suites - Zante - Greece



ARIA
Showroom ALU B.V.
Amsterdam - Netherlands



ARIA
Nira Montana - La Thuile - Italy

Palma·Erica Gardenia·Dalia





PALMA
bianco/tortora



PALMA - CUBE 70
tortora





ERICA
bianco



DALIA
tortora



ERICA - CUBE 70
bianco



GARDENIA
bianco / tortora

Ninfea·Loto

DINNER - RELAX





NINFEA RELAX
bianco



LOTO RELAX 95 - LOTO RELAX 60
bianco



NINFEA RELAX - LOTO RELAX 95
antracite



NINFEA DINNER - FLUTE
antracite



NINFEA DINNER
antracite



NINFEA DINNER
bianco

Dama·Regina·Duca





DAMA
tortora - burro



DAMA
tortora



DAMA
tortora



REGINA
antracite - burro



DUCA - SCUDO HIGH
tortora



REGINA - CALICE
antracite



Cube



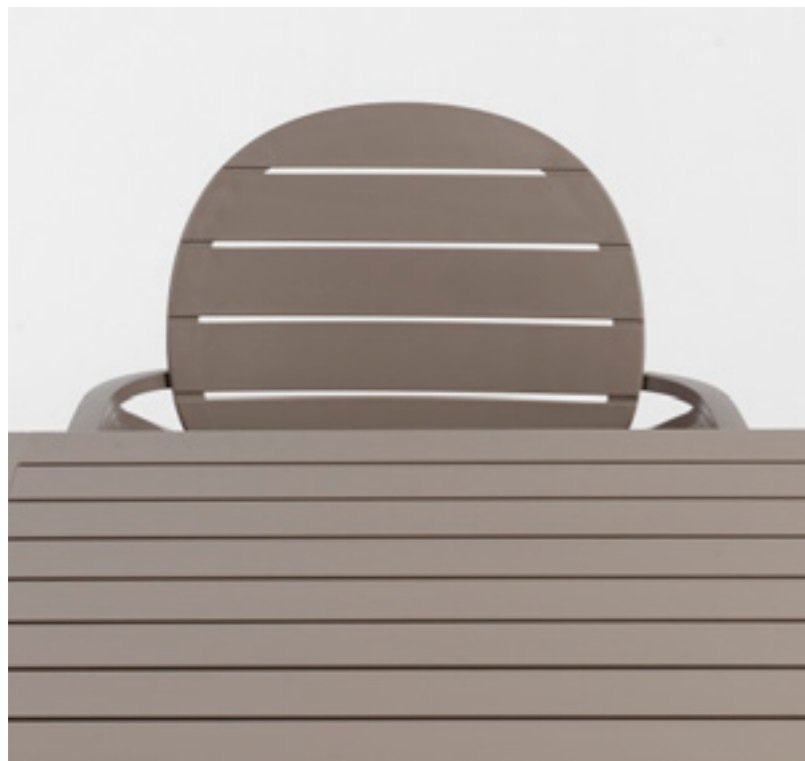

CUBE 80 - PALMA
tortora



CUBE 80 - 70 - 70 HIGH
tortora



CUBE 70
tortora



CUBE 140x80
tortora



CUBE 140x80 - 140x80 HIGH
tortora



CUBE 140x80 HIGH
bianco
NET STOOL
bianco

Clip

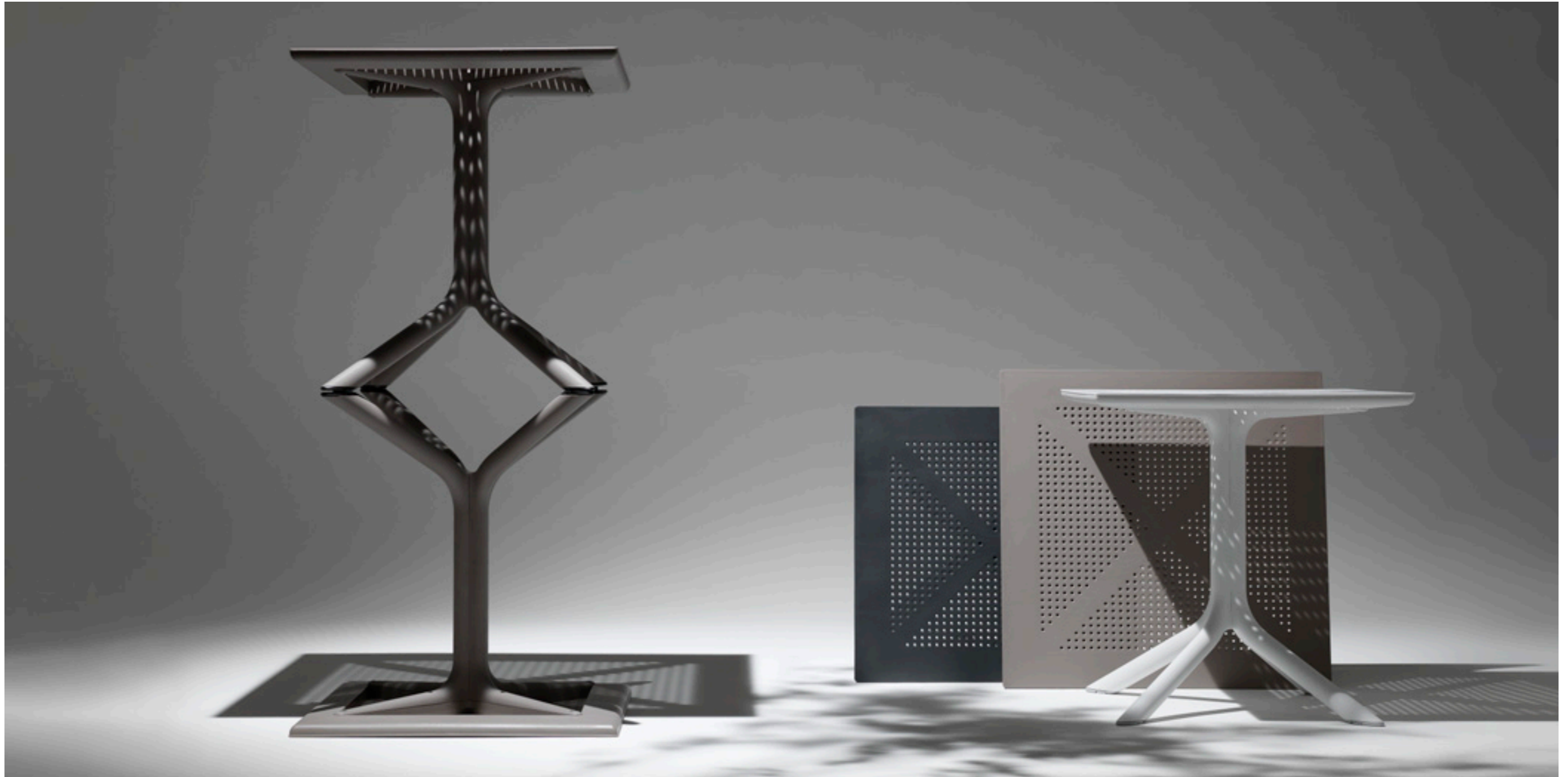



CLIP 80 - BORA
tortora

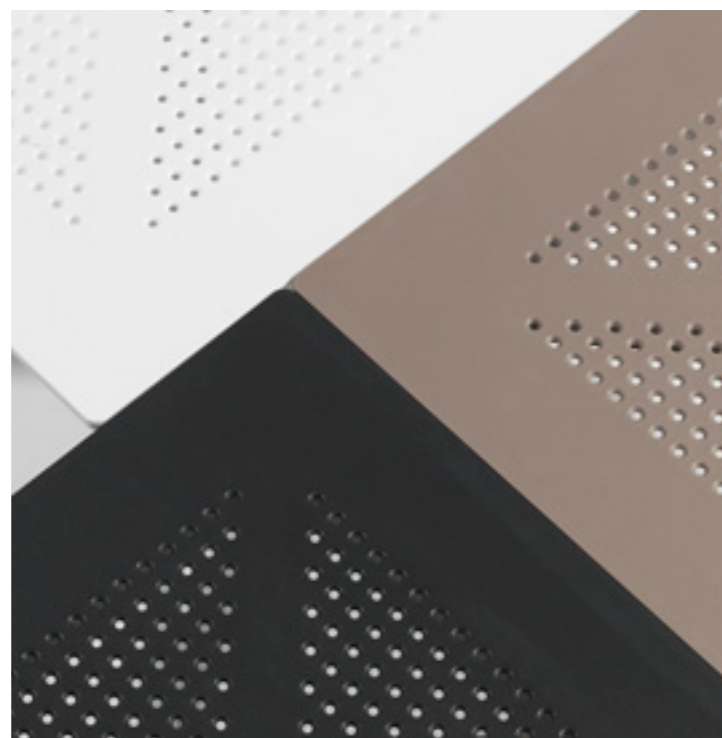

CLIP 70
bianco - antracite - tortora



CLIP 80 - CLIP 70 - BORA
tortora



CLIPX 80 - NET
tortora



BASE CLIP
bianco - piano Laminato 70x70 total white

Step·Spritz





STEP
rosso



STEP - BORA BISTROT
tortora



SPRITZ
antracite
SPRITZ MINI
tortora

Frasca

MINI - MAXI





FRASCA MAXI
agave - piano Laminato 90x90 agave
FRASCA MINI
agave - piano Laminato 70x70 agave



FRASCA MINI
agave



FRASCA MINI
 antracite - tortora - bianco - agave
 piani Laminato 70x70



FRASCA MAXI
 agave - piano Laminato 90x90 agave
TRILL BISTROT
 agave

Fiore·Ibisco





FIORE HIGH - FIORE
bianco - piano DurelTOP 70x70 bianco
FARO - RIVA BISTROT
celeste



FIORE
bianco - piano DurelTOP 70x70 bianco





IBISCO
tortora - piano Laminato 80x80 tortora



IBISCO HIGH
antracite - piano Laminato 70x70 antracite

Flute·Break





FLUTE
bianco - piano Laminato ø70 bianco



FLUTE
antracite - piano Laminato ø70 antracite



BREAK
bianco - piano Laminato ø70 bianco



BREAK
antracite - piano Laminato ø70 antracite



FLUTE
tortora
piano Laminato ø70 tortora

Scudo





SCUDO
tortora
piano Laminato 80x80 tortora



SCUDO HIGH - SCUDO
tortora
piano Laminato 70x70 tortora



SCUDO DOUBLE
antracite

Atlantico·Pop

SUNLOUNGER - TABLE





ATLANTICO - POP
antracite



POP
tortora



ATLANTICO
tortora/deserto -tortora/agave



ATLANTICO
tortora/tortora



ATLANTICO
tortora



ATLANTICO
bianco / tortora



ATLANTICO - SPRITZ
Villa Aieni - Puglia - Italy



ATLANTICO
Aqua Breeze Villas - Naxos - Greece



ATLANTICO
Deltapark Resort - Thun - Swiss



ATLANTICO
Sunmelia BeachResort Hotel & Spa - Antalya - Turkey



ATLANTICO
Moncastro Hotel - Odessa - Ukraine

Alfa·Omega

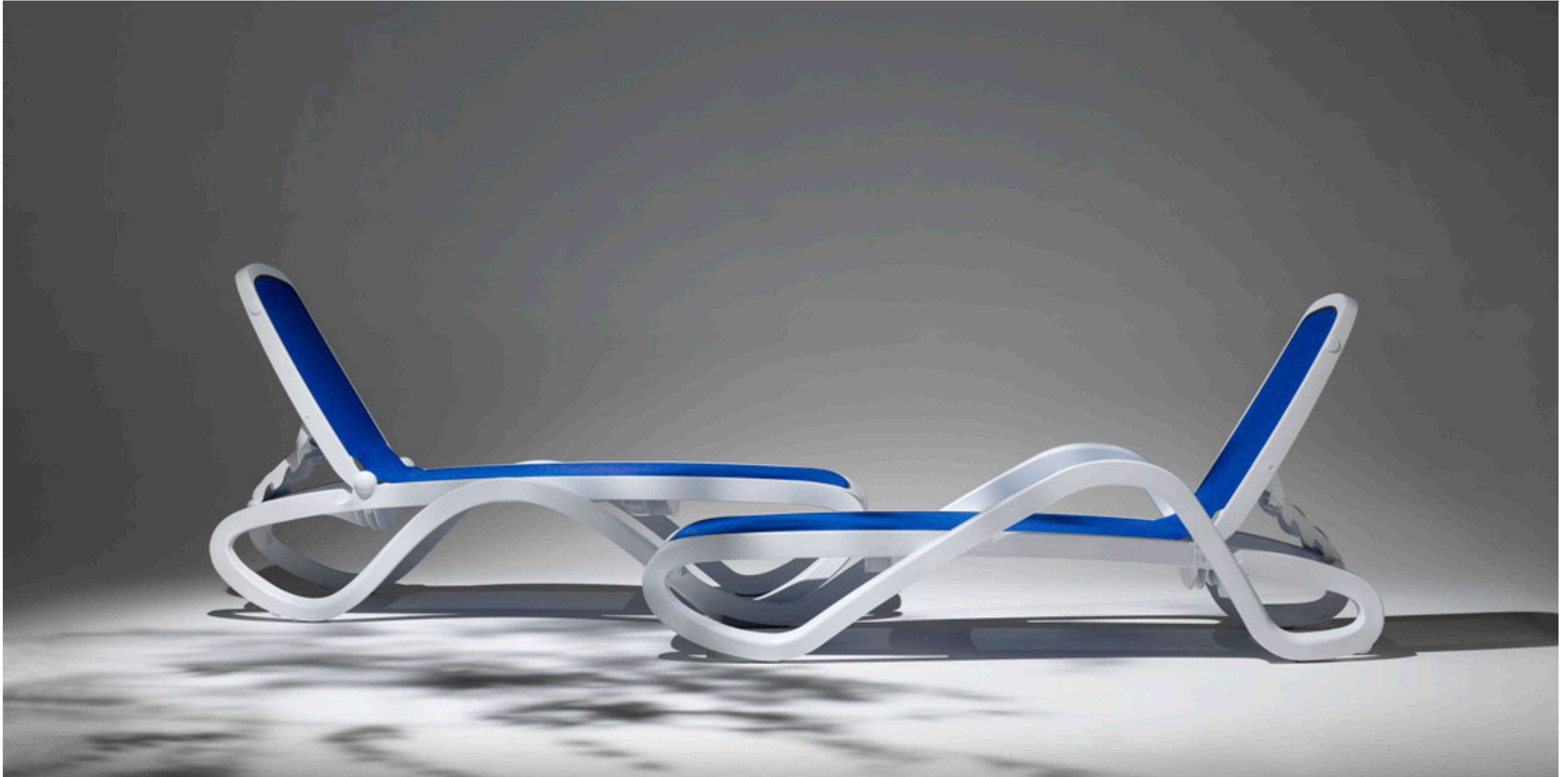

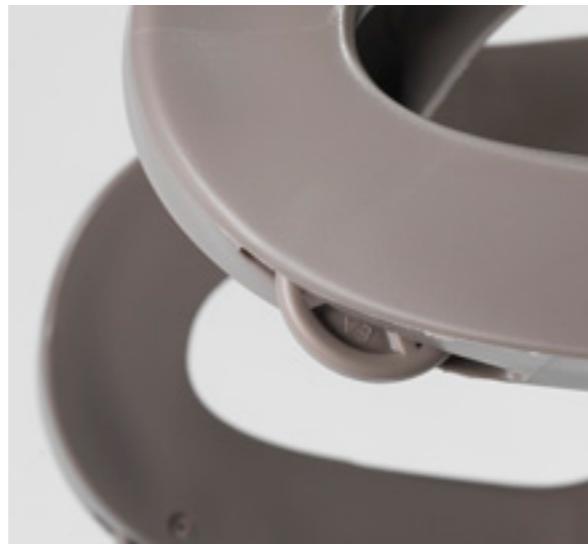

ALFA
tortora/tortora



OMEGA
grigio/grigio

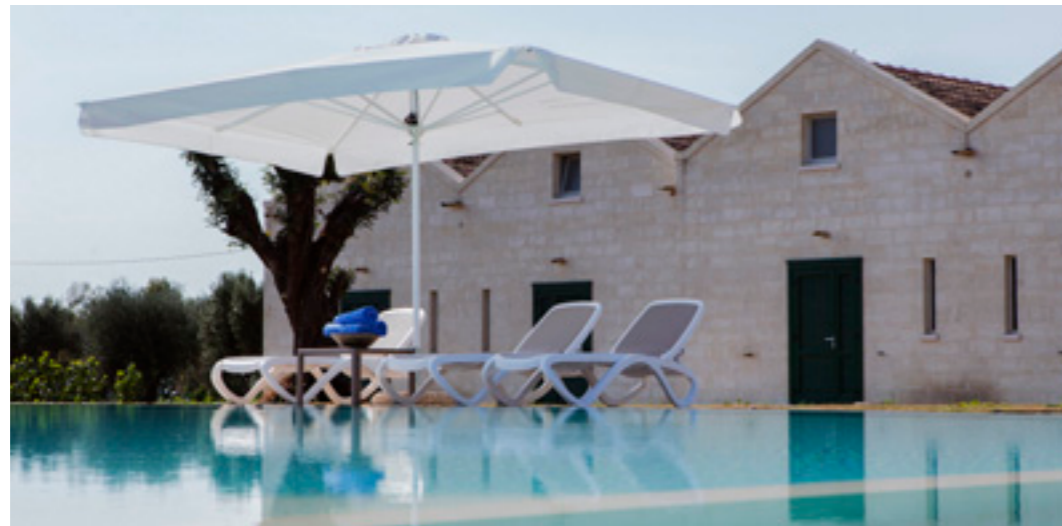

OMEGA
Agrumare Farm Holiday - Matera - Italy



OMEGA
Cave Bianche Hotel - Trapani - Italy

schede tecniche
technical details

KOMODO

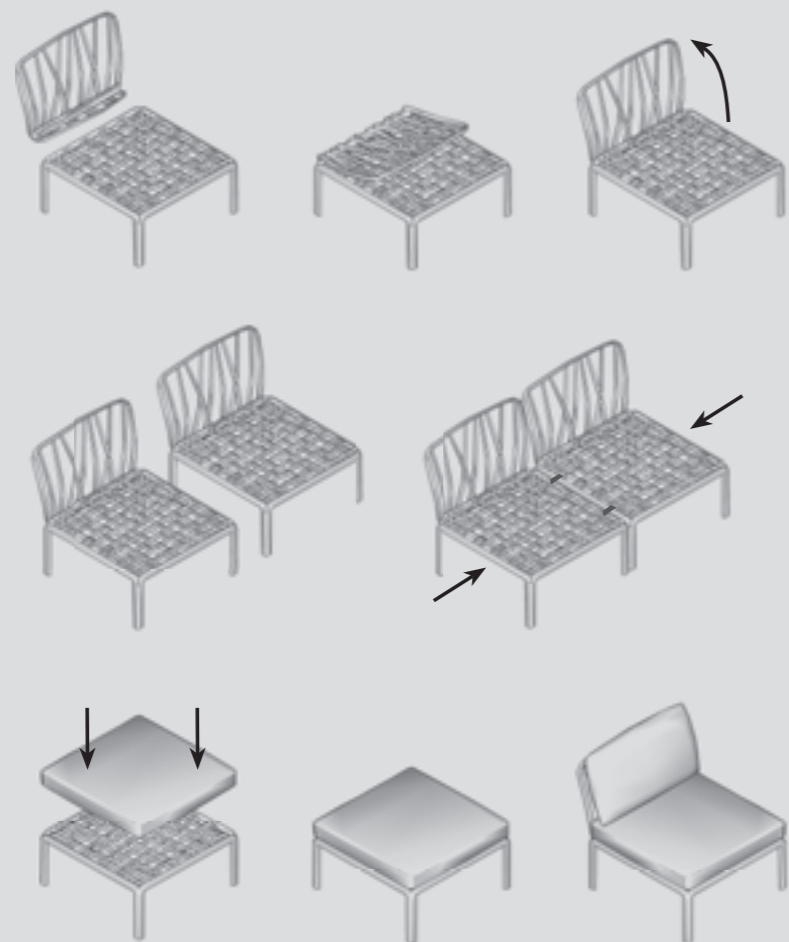

KOMODO è un sistema modulare di sedute configurabile a piacere. I moduli possono essere fissati tra loro e gli schienali e i braccioli sono agganciabili su tutti i lati della seduta.

Oltre alla versione standard KOMODO 5, è possibile configurare e ordinare la tua versione personalizzata elencando tutti i singoli elementi che la formano.

KOMODO is a modular system of upholstered seats which can be configured to suit your particular needs. The modules can be secured to one another and the backrests and armrests can be attached on all sides of the seat.

In addition to the standard KOMODO 5 version, you can configure and order your own customized version simply by listing all the individual elements you require.

KOMODO POLTRONA

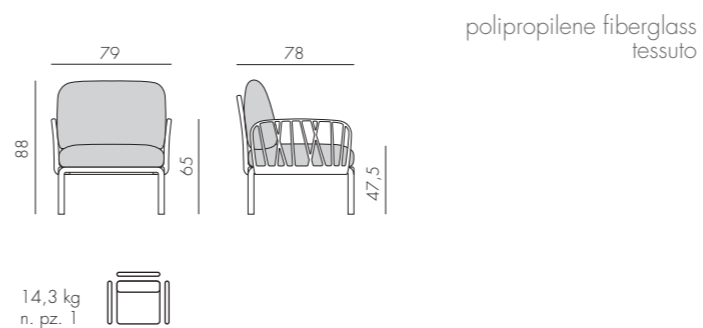

KOMODO ELEMENTO TERMINALE DX/SX

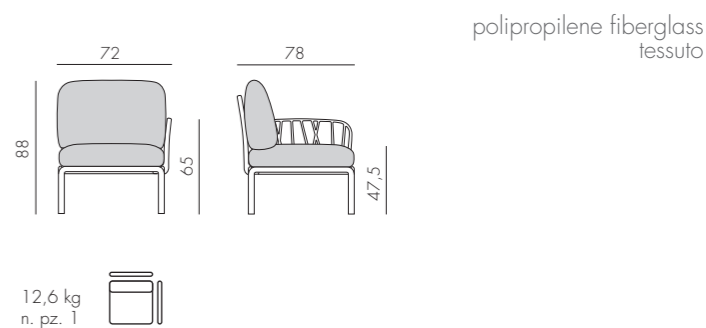

KOMODO ELEMENTO CENTRALE

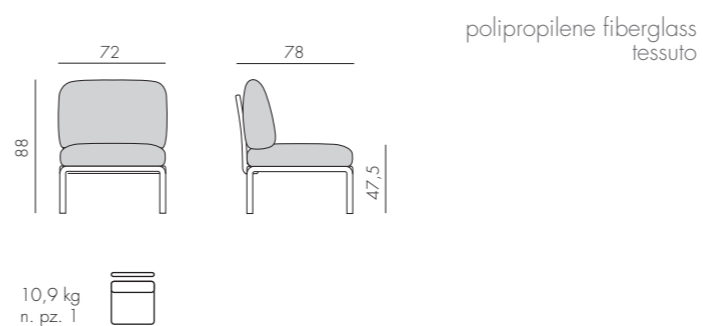

KOMODO ELEMENTO ANGOLO

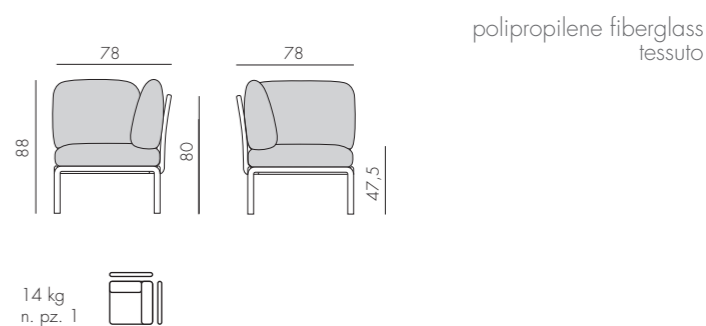

KOMODO POUF



KOMODO 5

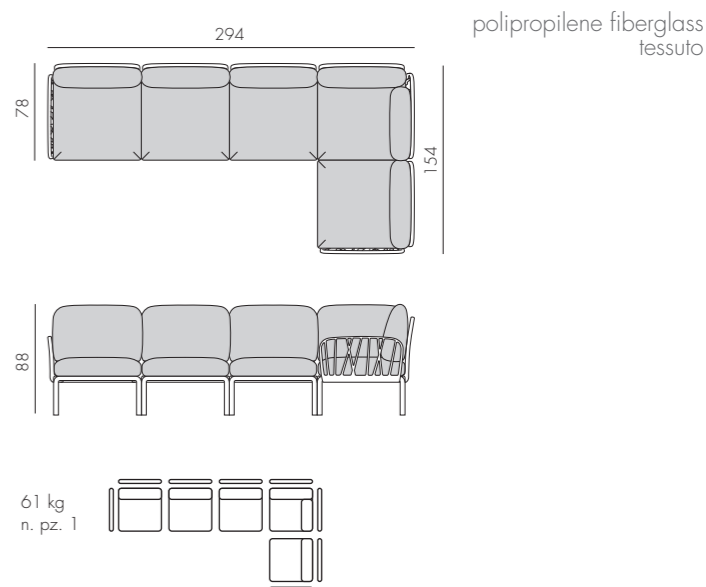



BIANCO rosa quarzo		40371.00.066	40372.00.066	40373.00.066	40374.00.066	40369.00.066	40370.00.066
ANTRACITE rosa quarzo		40371.02.066	40372.02.066	40373.02.066	40374.02.066	40369.02.066	40370.02.066
TORTORA rosa quarzo		40371.10.066	40372.10.066	40373.10.066	40374.10.066	40369.10.066	40370.10.066
new AGAVE rosa quarzo		40371.16.066	40372.16.066	40373.16.066	40374.16.066	40369.16.066	40370.16.066

BIANCO grigio		40371.00.163	40372.00.163	40373.00.163	40374.00.163	40369.00.163	40370.00.163
ANTRACITE grigio		40371.02.163	40372.02.163	40373.02.163	40374.02.163	40369.02.163	40370.02.163
TORTORA grigio		40371.10.163	40372.10.163	40373.10.163	40374.10.163	40369.10.163	40370.10.163
new AGAVE grigio		40371.16.163	40372.16.163	40373.16.163	40374.16.163	40369.16.163	40370.16.163



BIANCO adriatic Sunbrella®		40371.00.142	40372.00.142	40373.00.142	40374.00.142	40369.00.142	40370.00.142
ANTRACITE adriatic Sunbrella®		40371.02.142	40372.02.142	40373.02.142	40374.02.142	40369.02.142	40370.02.142
TORTORA adriatic Sunbrella®		40371.10.142	40372.10.142	40373.10.142	40374.10.142	40369.10.142	40370.10.142
new AGAVE adriatic Sunbrella®		40371.16.142	40372.16.142	40373.16.142	40374.16.142	40369.16.142	40370.16.142

new BIANCO ghiaccio Sunbrella®		40371.00.138	40372.00.138	40373.00.138	40374.00.138	40369.00.138	40370.00.138
new ANTRACITE ghiaccio Sunbrella®		40371.02.138	40372.02.138	40373.02.138	40374.02.138	40369.02.138	40370.02.138
new TORTORA ghiaccio Sunbrella®		40371.10.138	40372.10.138	40373.10.138	40374.10.138	40369.10.138	40370.10.138
new AGAVE ghiaccio Sunbrella®		40371.16.138	40372.16.138	40373.16.138	40374.16.138	40369.16.138	40370.16.138



new BIANCO avocado Sunbrella®		40371.00.139	40372.00.139	40373.00.139	40374.00.139	40369.00.139	40370.00.139
new ANTRACITE avocado Sunbrella®		40371.02.139	40372.02.139	40373.02.139	40374.02.139	40369.02.139	40370.02.139
new TORTORA avocado Sunbrella®		40371.10.139	40372.10.139	40373.10.139	40374.10.139	40369.10.139	40370.10.139
new AGAVE avocado Sunbrella®		40371.16.139	40372.16.139	40373.16.139	40374.16.139	40369.16.139	40370.16.139
new BIANCO giungla Sunbrella®		40371.00.140	40372.00.140	40373.00.140	40374.00.140	40369.00.140	40370.00.140
new ANTRACITE giungla Sunbrella®		40371.02.140	40372.02.140	40373.02.140	40374.02.140	40369.02.140	40370.02.140
new TORTORA giungla Sunbrella®		40371.10.140	40372.10.140	40373.10.140	40374.10.140	40369.10.140	40370.10.140
new AGAVE giungla Sunbrella®		40371.16.140	40372.16.140	40373.16.140	40374.16.140	40369.16.140	40370.16.140



new BIANCO canvas Sunbrella® laminato		40371.00.170	40372.00.170	40373.00.170	40374.00.170	40369.00.170	40370.00.170
new ANTRACITE canvas Sunbrella® laminato		40371.02.170	40372.02.170	40373.02.170	40374.02.170	40369.02.170	40370.02.170
new TORTORA canvas Sunbrella® laminato		40371.10.170	40372.10.170	40373.10.170	40374.10.170	40369.10.170	40370.10.170
new AGAVE canvas Sunbrella® laminato		40371.16.170	40372.16.170	40373.16.170	40374.16.170	40369.16.170	40370.16.170
new BIANCO TECH panama		40371.00.131	40372.00.131	40373.00.131	40374.00.131	40369.00.131	40370.00.131
new ANTRACITE TECH panama		40371.02.131	40372.02.131	40373.02.131	40374.02.131	40369.02.131	40370.02.131
new TORTORA TECH panama		40371.10.131	40372.10.131	40373.10.131	40374.10.131	40369.10.131	40370.10.131
new AGAVE TECH panama		40371.16.131	40372.16.131	40373.16.131	40374.16.131	40369.16.131	40370.16.131

KOMODO TAVOLINO

polipropilene fiberglass

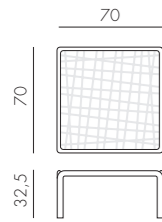

6,7 kg
n. pz. 1



BIANCO 40378.00.000
ANTRACITE 40378.02.000
TORTORA 40378.10.000
AGAVE 40378.16.000

KOMODO TAVOLINO VETRO **new**

polipropilene fiberglass
vetro

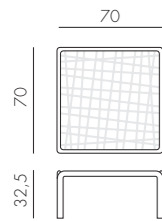

11,4 kg
n. pz. 1



BIANCO vetro 40368.00.501
ANTRACITE vetro 40368.02.501
TORTORA vetro 40368.10.501
AGAVE vetro 40368.16.501

KOMODO BRACCIOLO

polipropilene fiberglass

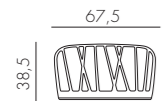

1,7 kg
n. pz. 2



BIANCO 40375.00.000
ANTRACITE 40375.02.000
TORTORA 40375.10.000
AGAVE 40375.16.000

KOMODO SCHIENALE

polipropilene fiberglass

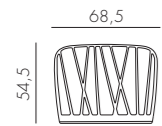

2 kg
n. pz. 4



BIANCO 40376.00.000
ANTRACITE 40376.02.000
TORTORA 40376.10.000
AGAVE 40376.16.000

KOMODO ECOWALL **new**

polipropilene fiberglass rigenerato

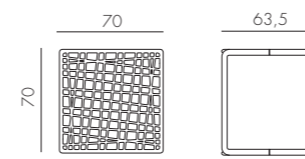

10 kg
n. pz. 1



TERRA
40380.44.000

CUSCINO SCHIENALE KOMODO

tessuto

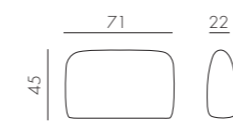

1,4 kg
n. pz. 1



rosa quarzo
36370.52.066



grigio
36370.52.163

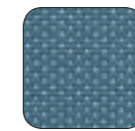

adriatic Sunbrella®
36370.52.142



new
ghiaccio Sunbrella®
36370.52.138



new
avocado Sunbrella®
36370.52.139

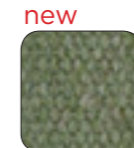

new
giungla Sunbrella®
36370.52.140



new
canvas Sunbrella®
laminato
36370.52.170



new
TECH panama
36370.52.131

CUSCINO SCHIENALE ANGOLO KOMODO

tessuto

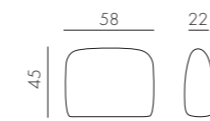

1,1 kg
n. pz. 1



rosa quarzo
36370.54.066



grigio
36370.54.163

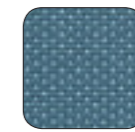

adriatic Sunbrella®
36370.54.142



new
ghiaccio Sunbrella®
36370.54.138



new
avocado Sunbrella®
36370.54.139

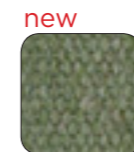

new
giungla Sunbrella®
36370.54.140



new
canvas Sunbrella®
laminato
36370.54.170



new
TECH panama
36370.54.131

TRILL ARMCHAIR

polipropilene fiberglass

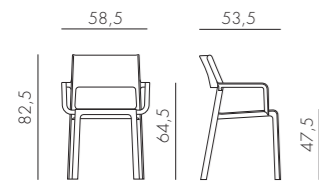

4,7 kg
n. pz. 6



BIANCO 40250.00.000 ANTRACITE 40250.02.000 GRIGIO 40250.03.000 ROSA BOUQUET 40250.08.000 TORTORA 40250.10.000 AGAVE 40250.16.000



OTTANIO 40250.49.000 TABACCO 40250.53.000 SENAPE 40250.56.000

TRILL STOOL

polipropilene fiberglass

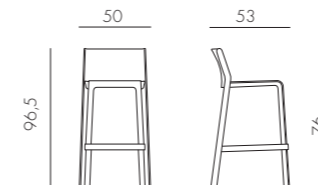

5,1 kg
n. pz. 4



BIANCO 40350.00.000 ANTRACITE 40350.02.000 GRIGIO 40350.03.000 ROSA BOUQUET 40350.08.000 TORTORA 40350.10.000 AGAVE 40350.16.000



OTTANIO 40350.49.000 TABACCO 40350.53.000 SENAPE 40350.56.000

TRILL BISTROT

polipropilene fiberglass

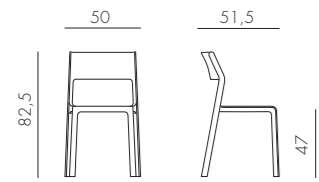

4,2 kg
n. pz. 6



BIANCO 40253.00.000 ANTRACITE 40253.02.000 GRIGIO 40253.03.000 ROSA BOUQUET 40253.08.000 TORTORA 40253.10.000 AGAVE 40253.16.000



OTTANIO 40253.49.000 TABACCO 40253.53.000 SENAPE 40253.56.000

TRILL STOOL MINI

polipropilene fiberglass

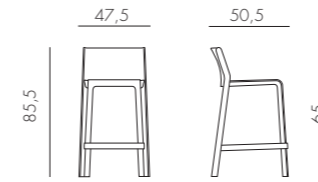

4,8 kg
n. pz. 4



BIANCO 40353.00.000 ANTRACITE 40353.02.000 GRIGIO 40353.03.000 ROSA BOUQUET 40353.08.000 TORTORA 40353.10.000 AGAVE 40353.16.000



OTTANIO 40353.49.000 TABACCO 40353.53.000 SENAPE 40353.56.000

NET BENCH

polipropilene fiberglass

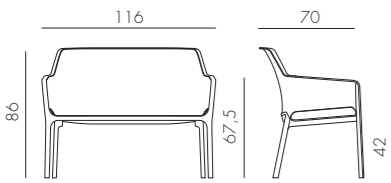

8,9 kg
n. pz. 20



BIANCO 40338.00.000 ANTRACITE 40338.02.000 SALICE 40338.04.000 TORTORA 40338.10.000 SENAPE 40338.56.000 CORALLO 40338.75.000

NET RELAX

polipropilene fiberglass

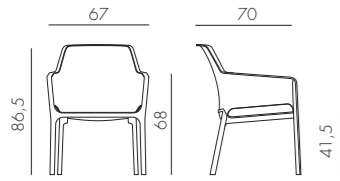

4,9 kg
n. pz. 20



pz. 6



BIANCO 40327.00.000 ANTRACITE 40327.02.000 SALICE 40327.04.000 TORTORA 40327.10.000 SENAPE 40327.56.000 CORALLO 40327.75.000

NET

polipropilene fiberglass

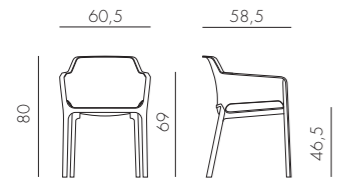

3,9 kg
n. pz. 6



pz. 6



BIANCO 40326.00.000.06 ANTRACITE 40326.02.000.06 SALICE 40326.04.000.06 TORTORA 40326.10.000.06 SENAPE 40326.56.000.06 CORALLO 40326.75.000.06

BIT

polipropilene fiberglass

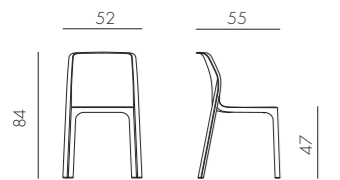

3,5 kg
n. pz. 6



BIANCO 40328.00.000.06 ANTRACITE 40328.02.000.06 SALICE 40328.04.000.06 TORTORA 40328.10.000.06 SENAPE 40328.56.000.06 CORALLO 40328.75.000.06

NET STOOL new

polipropilene fiberglass

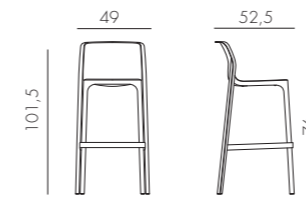

4,4 kg
n. pz. 4



BIANCO 40355.00.000 ANTRACITE 40355.02.000 SALICE 40355.04.000 TORTORA 40355.10.000 SENAPE 40355.56.000 CORALLO 40355.75.000

NET STOOL MINI new

polipropilene fiberglass

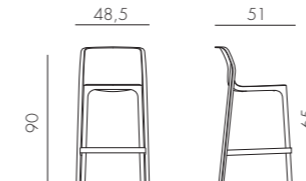

4,2 kg
n. pz. 4



BIANCO 40356.00.000 ANTRACITE 40356.02.000 SALICE 40356.04.000 TORTORA 40356.10.000 SENAPE 40356.56.000 CORALLO 40356.75.000

BORA

polipropilene fiberglass

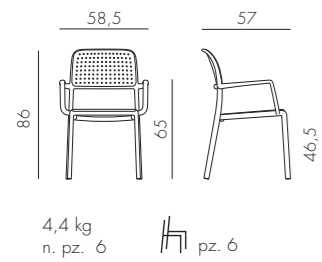

COSTA

polipropilene fiberglass

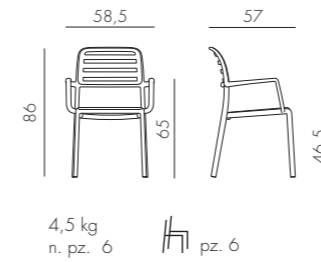

BORA BISTROT

polipropilene fiberglass

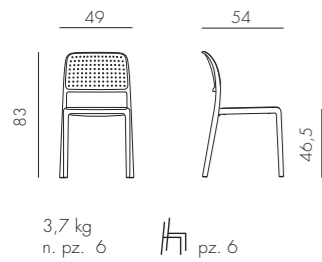

COSTA BISTROT

polipropilene fiberglass

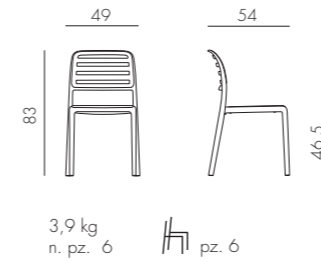

RIVA

polipropilene fiberglass

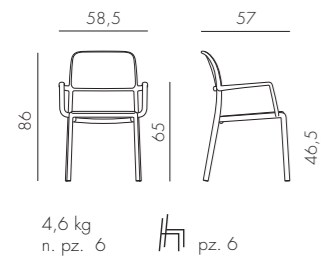

LIDO

polipropilene fiberglass

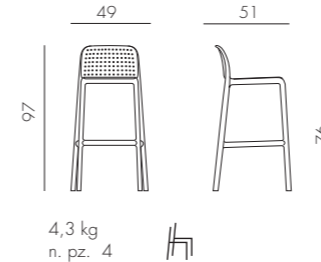

RIVA BISTROT

polipropilene fiberglass

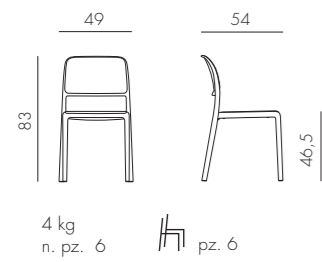

LIDO MINI

polipropilene fiberglass

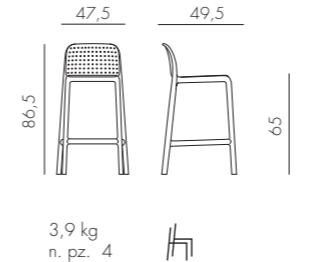

FARO

polipropilene fiberglass

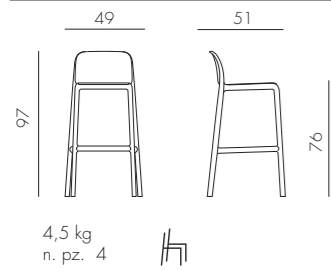

PALMA

polipropilene

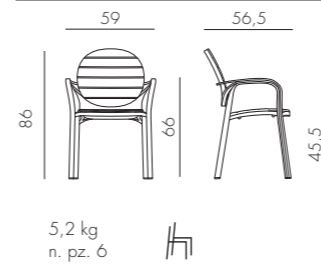

FARO MINI

polipropilene fiberglass

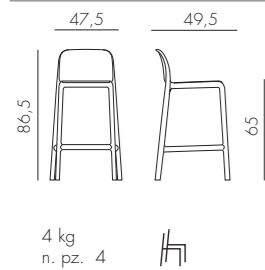

ERICA

polipropilene

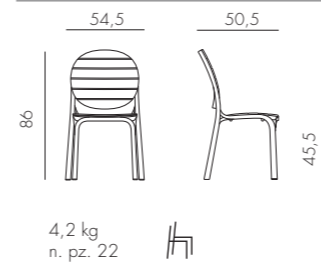

ACQUAMARINA

polipropilene fiberglass

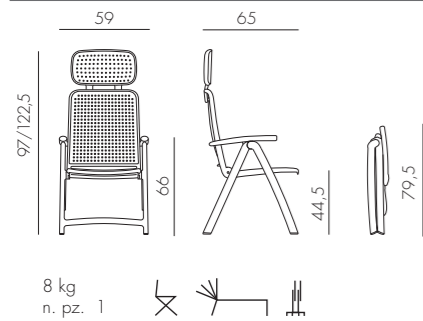

GARDENIA

polipropilene

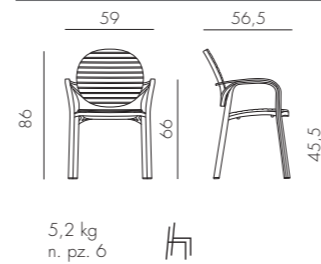

DARSENIA

polipropilene fiberglass

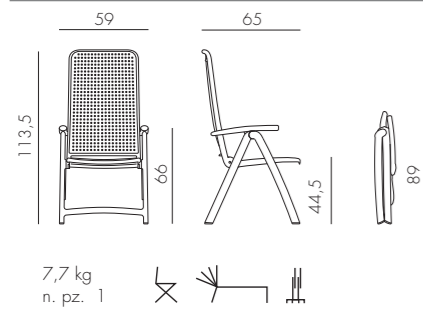

DALIA

polipropilene

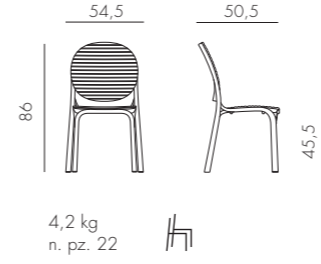

ARIA (POLTRONA ARIA + CUSCINO SEDUTA + CUSCINO ARREDO)

polipropilene
tessuto

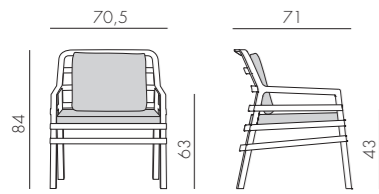

7,9 kg
n. pz. 1

BIANCO lime 40330.00.061.061	ANTRACITE lime 40330.02.061.061	TORTORA lime 40330.10.061.061
BIANCO cherry 40330.00.065.065	ANTRACITE cherry 40330.02.065.065	TORTORA cherry 40330.10.065.065
* new BIANCO sardinia 40330.00.072.072	* new ANTRACITE sardinia 40330.02.072.072	* new TORTORA sardinia 40330.10.072.072
BIANCO bianco 40330.00.155.155	ANTRACITE bianco 40330.02.155.155	TORTORA bianco 40330.10.155.155
BIANCO caffè 40330.00.165.165	ANTRACITE caffè 40330.02.165.165	TORTORA caffè 40330.10.165.165
BIANCO grigio 40330.00.163.163	ANTRACITE grigio 40330.02.163.163	TORTORA grigio 40330.10.163.163
BIANCO grigio Sunbrella@ 40330.00.136.136	ANTRACITE grigio Sunbrella@ 40330.02.136.136	TORTORA grigio Sunbrella@ 40330.10.136.136

* Disponibile a magazzino
Available ex-stock
Disponible sur stock
Ab Lager verfügbar
Disponible en almacén habitualmente
Disponível em estoque
Stokta mevcut
Наличие на складе

* Disponibile su ordine
Available to order
Disponible sur commande
Mit Auftrag verfügbar
Disponible sólo sobre pedido
Disponível sob encomenda
Sipariş göre hazırlanacaktır
Под заказ

ARIA FIT (POLTRONA ARIA + CUSCINO SEDUTA + CUSCINO FIT)

polipropilene
tessuto

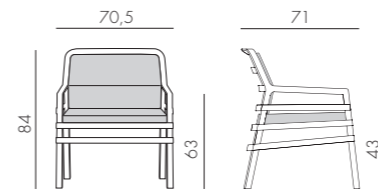

7,9 kg
n. pz. 1

BIANCO bianco 40330.00.155.FIT	ANTRACITE bianco 40330.02.155.FIT	TORTORA bianco 40330.10.155.FIT
BIANCO caffè 40330.00.165.FIT	ANTRACITE caffè 40330.02.165.FIT	TORTORA caffè 40330.10.165.FIT
BIANCO grigio 40330.00.163.FIT	ANTRACITE grigio 40330.02.163.FIT	TORTORA grigio 40330.10.163.FIT
BIANCO grigio Sunbrella@ 40330.00.136.FIT	ANTRACITE grigio Sunbrella@ 40330.02.136.FIT	TORTORA grigio Sunbrella@ 40330.10.136.FIT

* Disponibile su ordine
Available to order
Disponible sur commande
Mit Auftrag verfügbar
Disponible sólo sobre pedido
Disponível sob encomenda
Sipariş göre hazırlanacaktır
Под заказ

NINFEA DINNER

polipropilene
alluminio

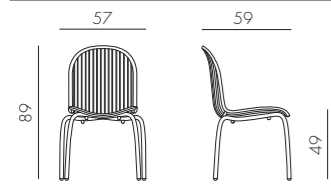

4,5 kg
n. pz. 6



ANTRACITE
verniciato antracite
62052.02.000

BIANCO
verniciato bianco
62053.00.000

NINFEA RELAX

polipropilene
alluminio

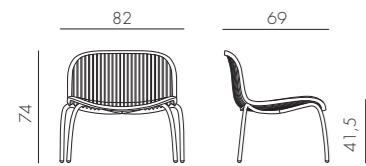

7,2 kg
n. pz. 2



ANTRACITE
verniciato antracite
62252.02.000

BIANCO
verniciato bianco
62253.00.000

DAMA

polipropilene fibreglass
alluminio

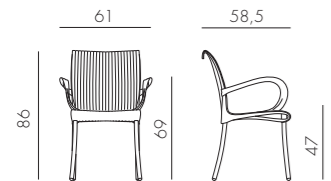

4,1 kg
n. pz. 18



ANTRACITE
verniciato antracite
61652.02.000

BURRO
verniciato burro
61658.28.000

TORTORA
verniciato tortora
61659.10.000

REGINA

polipropilene fibreglass
alluminio

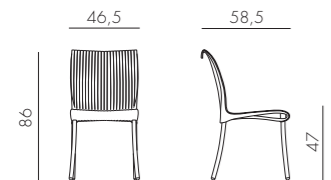

3,3 kg
n. pz. 18



ANTRACITE
verniciato antracite
61852.02.000

BURRO
verniciato burro
61858.28.000

TORTORA
verniciato tortora
61859.10.000

DUCA

polipropilene fibreglass
alluminio

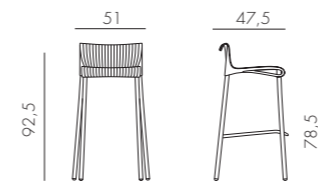

3,9 kg
n. pz. 4



ANTRACITE
verniciato antracite
75252.02.000

BURRO
verniciato burro
75258.28.000

TORTORA
verniciato tortora
75259.10.000

MUSA

polipropilene
alluminio

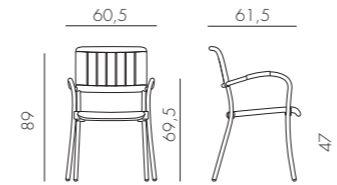

4,2 kg
n. pz. 24



ANTRACITE
verniciato antracite
61052.02.000

TORTORA
verniciato tortora
61059.10.000

ATLANTICO

polipropilene fiberglass
tessuto sintetico

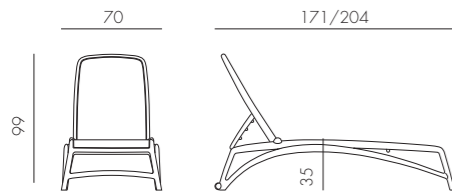

1,6 kg
n. pz. 20

Tessuto ricambiabile
Replaceable fabric
Tissu changeable
Auswechselbarer Stoff
Tela sustituibile
Tecidos recambiáveis
Değiştirilebilen Kumaş
Съемная ткань

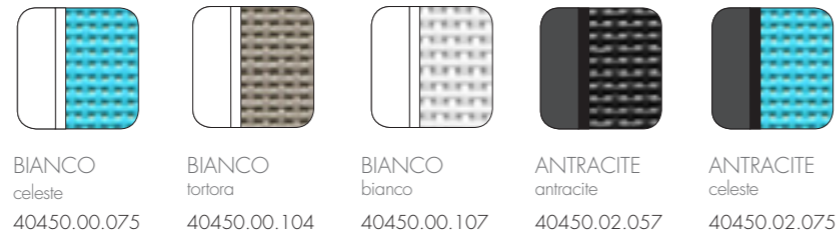

BRACCIOLO ATLANTICO

polipropilene fiberglass

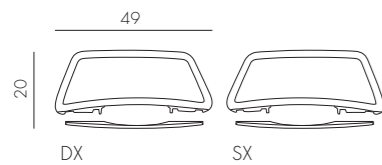

1,1 kg
n. pz. 1

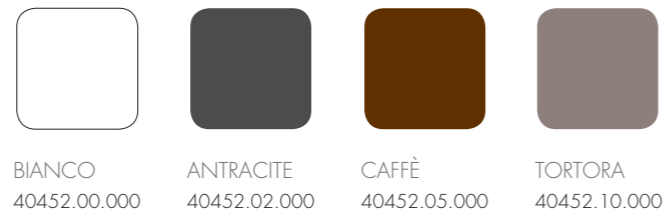

RICAMBIO atlantico

resina acetlica
tessuto sintetico

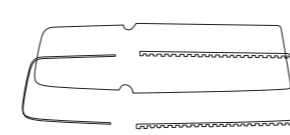

1,3 kg
n. pz. 1

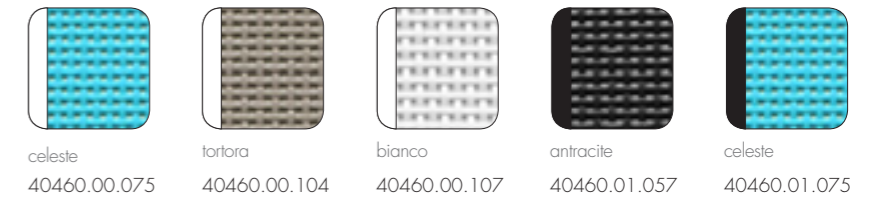

ALFA

polipropilene
tessuto sintetico

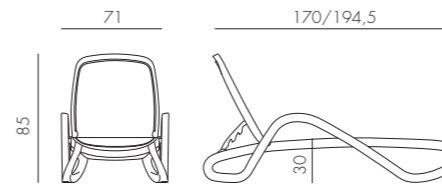

14 kg
n. pz. 17

Tessuto ricambiabile
Replaceable fabric
Tissu changeable
Auswechselbarer Stoff
Tela sustituibile
Tecidos recambiáveis
Değiştirilebilen Kumaş
Съемная ткань

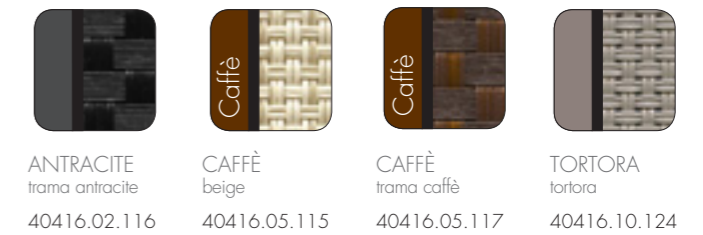

OMEGA

polipropilene
tessuto sintetico

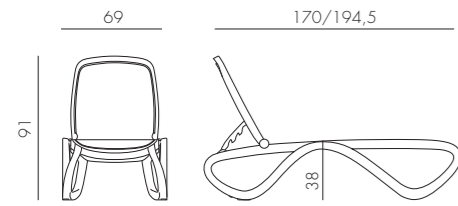

14,3 kg
n. pz. 18

Tessuto ricambiabile
Replaceable fabric
Tissu changeable
Auswechselbarer Stoff
Tela sustituible
Tecidos recambiáveis
Değiştirilebilen Kumaş
Съемная ткань

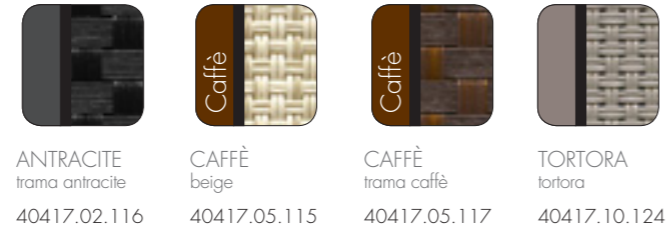

RICAMBIO ALFA - OMEGA

resina acetalica
tessuto sintetico

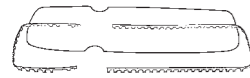

1,6 kg
n. pz. 1

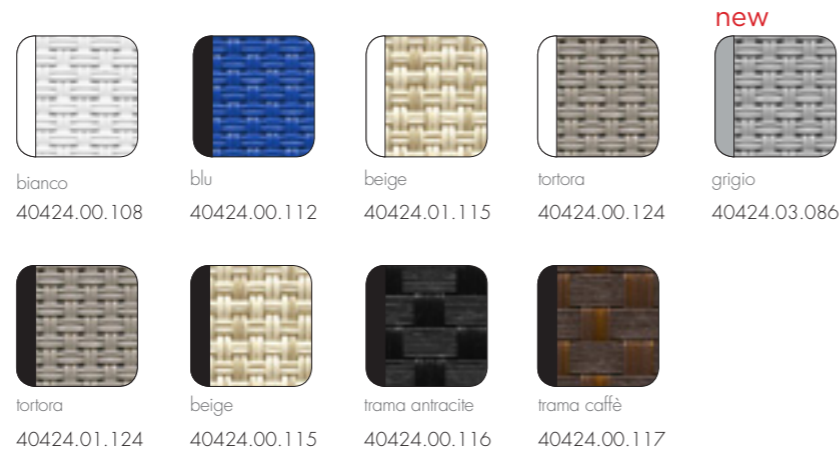

EDEN

polipropilene

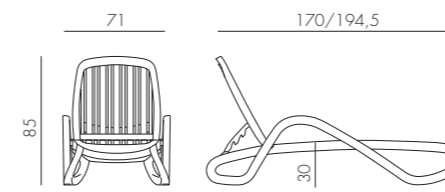

14,7 kg
n. pz. 17

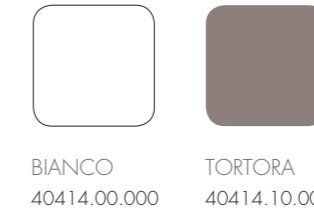

TROPICO

polipropilene

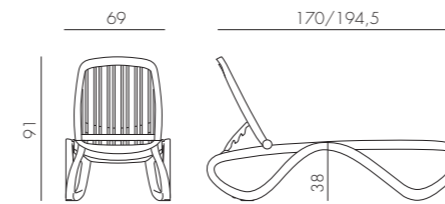

15,1 kg
n. pz. 18



PARASOLE ALFA - OMEGA - EDEN - TROPICO

polipropilene
tessuto sintetico

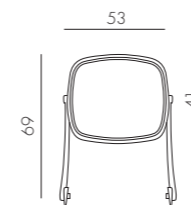

1,4 kg
n. pz. 1



CLIP 80

durelTOP
polipropilene fiberglass

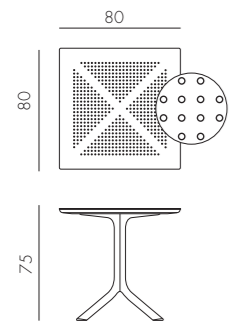

BIANCO 40082.00.000
ANTRACITE 40082.02.000
TORTORA 40082.10.000

12,1 kg
n. pz. 1

CLIP 70

durelTOP
polipropilene fiberglass

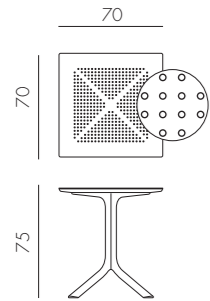

BIANCO 40084.00.000
ANTRACITE 40084.02.000
TORTORA 40084.10.000

11 kg
n. pz. 1

CLIPX 80

durelTOP
polipropilene fiberglass

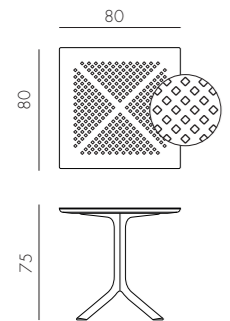

BIANCO 40083.00.000
ANTRACITE 40083.02.000
TORTORA 40083.10.000

11,7 kg
n. pz. 1

CLIPX 70

durelTOP
polipropilene fiberglass

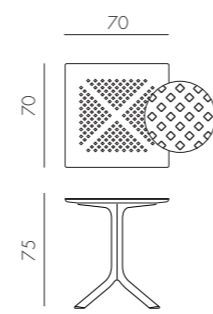

BIANCO 40085.00.000
ANTRACITE 40085.02.000
TORTORA 40085.10.000

10,7 kg
n. pz. 1

BASE CLIP

TOP Ø80 - 70X70 - 80X80

polipropilene fiberglass

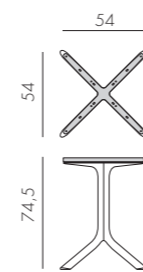

BIANCO 40088.00.000
ANTRACITE 40088.02.000
TORTORA 40088.10.000

8,1 kg
n. pz. 1

STEP

polipropilene fiberglass

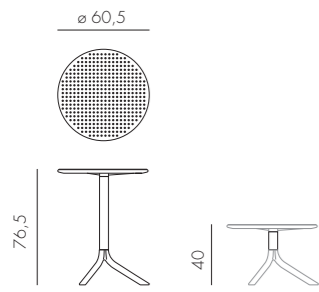

4,2 kg
n. pz. 1



SPRITZ

polipropilene fiberglass

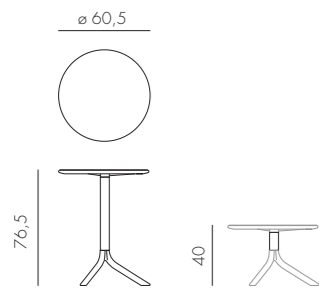

4,3 kg
n. pz. 1



NET TABLE 100

polipropilene fiberglass

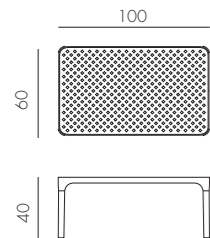

6,3 kg
n. pz. 1



ARIA TAVOLINO 100

polipropilene

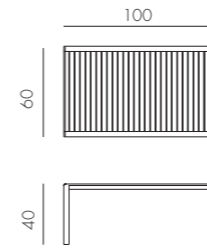

8 kg
n. pz. 1



BIANCO 40052.00.000	ANTRACITE 40052.02.000	TORTORA 40052.10.000
------------------------	---------------------------	-------------------------

ARIA TAVOLINO 60

polipropilene



5 kg
n. pz. 1



BIANCO 40051.00.000	ANTRACITE 40051.02.000	TORTORA 40051.10.000
------------------------	---------------------------	-------------------------

POP

polipropilene fiberglass

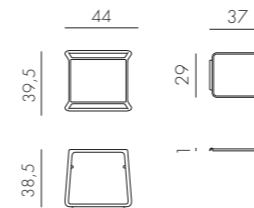

2,5 kg
n. pz. 4



BIANCO 40048.00.000	ANTRACITE 40048.02.000	CAFFÈ 40048.05.000	TORTORA 40048.10.000
------------------------	---------------------------	-----------------------	-------------------------

CUBE 140X80 new

durelTOP - polipropilene
alluminio

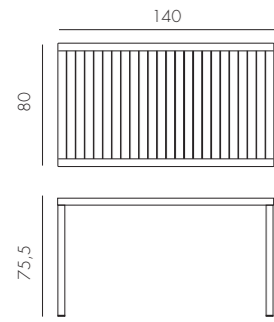

			
BIANCO verniciato bianco 47753.00.000	ANTRACITE * verniciato antracite 47752.02.000	CAFFÈ * verniciato caffè 47757.05.000	TORTORA verniciato tortora 47759.10.000

16,9 kg
n. pz. 1 

CUBE 80

durelTOP - polipropilene
alluminio

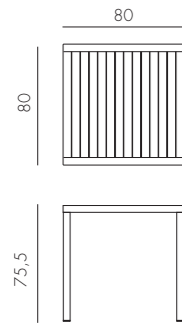

			
BIANCO verniciato bianco 48053.00.000	ANTRACITE verniciato antracite 48052.02.000	CAFFÈ verniciato caffè 48057.05.000	TORTORA verniciato tortora 48059.10.000

11,5 kg
n. pz. 1 

CUBE 70

durelTOP - polipropilene
alluminio

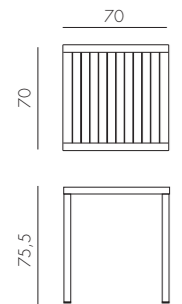

			
BIANCO verniciato bianco 47853.00.000	ANTRACITE verniciato antracite 47852.02.000	CAFFÈ verniciato caffè 47857.05.000	TORTORA verniciato tortora 47859.10.000





9,5 kg
n. pz. 1 

* Posizionare in zona d'ombra - Only use table tops in shaded areas - Plateaux qui doivent être utilisés uniquement dans des zones ombragées - Tischplatten nur für beschatteten Einsatzbereich - Utilizar estos tableros sólo en áreas sombreadas - Colocar em local sombreado - Gölge alana koyun - Ставить в тени

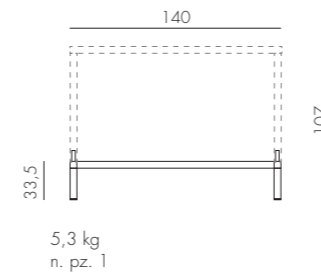
KIT CUBE 140X80 HIGH new

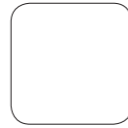
alluminio







			
verniciato bianco 46953.00.000	verniciato antracite 46952.02.000	verniciato caffè 46957.05.000	verniciato tortora 46959.10.000

5,3 kg
n. pz. 1

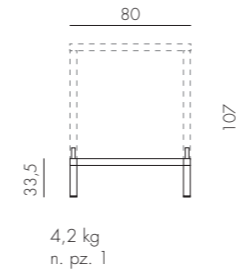
KIT CUBE 80 HIGH

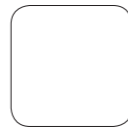
alluminio







			
verniciato bianco 48153.00.000	verniciato antracite 48152.02.000	verniciato caffè 48157.05.000	verniciato tortora 48159.10.000

4,2 kg
n. pz. 1

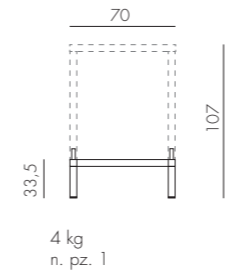
KIT CUBE 70 HIGH

alluminio



			
verniciato bianco 47953.00.000	verniciato antracite 47952.02.000	verniciato caffè 47957.05.000	verniciato tortora 47959.10.000

4 kg
n. pz. 1

MAESTRALE 90

DurelTOP - polipropilene
alluminio

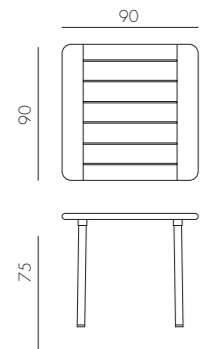

11,7 kg
n. pz. 1



ANTRACITE *
verniciato antracite
42052.02.000

TORTORA
verniciato tortora
42059.10.000

LOTO RELAX 95

vetro
alluminio

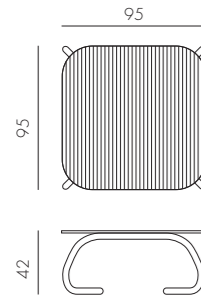

27 kg
n. pz. 1



ANTRACITE
verniciato antracite
44752.02.000

BIANCO
verniciato bianco
44753.00.000

LOTO RELAX 60

laminato
alluminio

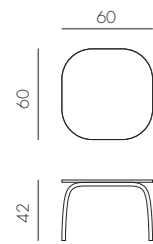

7 kg
n. pz. 1



ANTRACITE *
verniciato antracite
44652.00.303

BIANCO
verniciato bianco
44653.00.301

* Posizionare in zona d'ombra - Only use table tops in shaded areas - Plateaux qui doivent être utilisés uniquement dans des zones ombragées - Tischplatten nur für beschatteten Einsatzbereich - Utilizar estos tableros sólo en áreas sombreadas - Colocar em local sombreado - Gölge alana koyun - Ставить в тени

BASE FRASCA MAXI

new

PIANI Ø80 - Ø90 - 80X80 - 90X90

alluminio

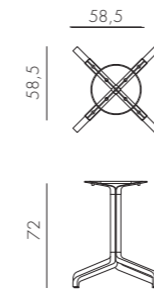

9,9 kg
n. pz. 1



verniciato antracite
53652.00.000
■ 53652.00.000.01

verniciato bianco
53653.00.000
■ 53653.00.000.01

verniciato tortora
53659.00.000
■ 53659.00.000.01

verniciato agave
53666.00.000
■ 53666.00.000.01

BASE FRASCA MINI

new

PIANI Ø60 - Ø70 - 60X60 - 70X70

alluminio

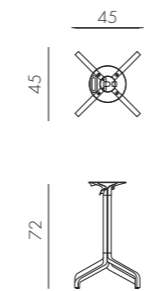

5,3 kg
n. pz. 1



verniciato antracite
53252.00.000
■ 53252.00.000.01

verniciato bianco
53253.00.000
■ 53253.00.000.01

verniciato tortora
53259.00.000
■ 53259.00.000.01

verniciato agave
53266.00.000
■ 53266.00.000.01

■ trattamento speciale per ambienti ad alto tasso salino - special treatment for high salinity environments - traitement spécial pour les environnements a haute salinité - Sonderbehandlung für Ambiente mit hohem Salzgehalt - tratamiento especial para ambientes con alta salinidad - tratamento especial para ambientes com alto teor de sal - yüksek tuza maruz kalan alanlar için özel bakım - Специальная обработка для среды с высоким содержанием соли

Qualora il prodotto venga posizionato in ambienti altamente salini raccomandiamo di scegliere una base con trattamento speciale. If the product is placed in highly salty environments, we recommend choosing a base with a special treatment. Si le produit est placé dans des environnements a haute salinite, nous recommandons de choisir une base avec un traitement spécial. Wenn das Produkt in der Umgebung mit hohem Salzgehalt platziert ist, empfehlen wir, eine Basis mit Sonderbehandlung zu wählen. Si el producto se coloca en ambientes con alta salinidad, recomendamos elegir una base con un tratamiento especial. Se o produto for exposto em ambientes com alto teor de salinidade, recomendamos a escolha de uma base com tratamento especial. Ürünün, salinitesi yüksek olan ortamlarda kullanılması durumunda, özel muamele görmüş versiyonun seçilmesi tavsiye olunur. Если изделие будет использоваться в среде с высоким содержанием соли, рекомендуется выбирать основание со специальной обработкой.

BASE IBISCO

PIANI Ø60 - Ø70 - Ø80 - 60X60 - 70X70 - 80X80

alluminio

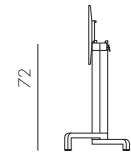
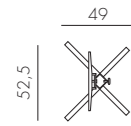

6 kg
n. pz. 1



BASE IBISCO HIGH

PIANI Ø60 - Ø70 - 60X60 - 70X70

alluminio

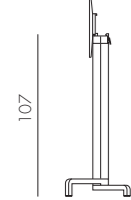
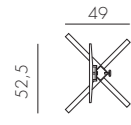

6,7 kg
n. pz. 1



BASE FIORE

PIANI Ø60 - Ø70 - Ø80 - 60X60 - 70X70 - 80X80

alluminio

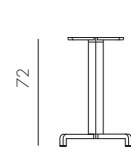
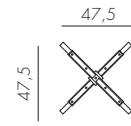

5 kg
n. pz. 1



BASE FIORE HIGH

PIANI Ø60 - Ø70 - 60X60 - 70X70

alluminio

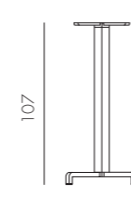
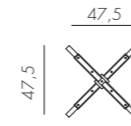

5,7 kg
n. pz. 1



BASE SCUDO

PIANI Ø60 - Ø70 - Ø80 - 60X60 - 70X70 - 80X80

alluminio

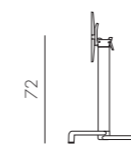
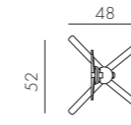

5,8 kg
n. pz. 1



BASE SCUDO HIGH

PIANI Ø60 - Ø70 - 60X60 - 70X70

alluminio

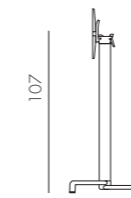
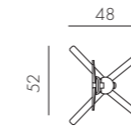

6,7 kg
n. pz. 1



■ trattamento speciale per ambienti ad alto tasso salino - special treatment for high salinity environments - traitement spécial pour les environnements a haute salinité - Sonderbehandlung für Ambiente mit hohem Salzgehalt - tratamiento especial para ambientes con alta salinidad - tratamiento especial para ambientes con alto teor de sal - yüksek tuza maruz kalan alanlar için özel bakım - Специальная обработка для среды с высоким содержанием соли

Qualora il prodotto venga posizionato in ambienti altamente salini raccomandiamo di scegliere una base con trattamento speciale. If the product is placed in highly salty environments, we recommend choosing a base with a special treatment. Si le produit est placé dans des environnements a haute salinite, nous recommandons de choisir une base avec un traitement spécial. Wenn das Produkt in der Umgebung mit hohem Salzgehalt platziert ist, empfehlen wir, eine Basis mit Sonderbehandlung zu wählen. Si el producto se coloca en ambientes con alta salinidad, recomendamos elegir una base con un tratamiento especial. Se o produto for exposto em ambientes com alto teor de salinidade, recomendamos a escolha de uma base com tratamento especial. Ürünün, salinitesi yüksek olan ortamlarda kullanılması durumunda, özel muamele görmüş versiyonun seçilmesi tavsiye olunur. Если изделие будет использоваться в среде с высоким содержанием соли, рекомендуется выбрать основание со специальной обработкой.

■ trattamento speciale per ambienti ad alto tasso salino - special treatment for high salinity environments - traitement spécial pour les environnements a haute salinité - Sonderbehandlung für Ambiente mit hohem Salzgehalt - tratamiento especial para ambientes con alta salinidad - tratamiento especial para ambientes con alto teor de sal - yüksek tuza maruz kalan alanlar için özel bakım - Специальная обработка для среды с высоким содержанием соли

Qualora il prodotto venga posizionato in ambienti altamente salini raccomandiamo di scegliere una base con trattamento speciale. If the product is placed in highly salty environments, we recommend choosing a base with a special treatment. Si le produit est placé dans des environnements a haute salinite, nous recommandons de choisir une base avec un traitement spécial. Wenn das Produkt in der Umgebung mit hohem Salzgehalt platziert ist, empfehlen wir, eine Basis mit Sonderbehandlung zu wählen. Si el producto se coloca en ambientes con alta salinidad, recomendamos elegir una base con un tratamiento especial. Se o produto for exposto em ambientes com alto teor de salinidade, recomendamos a escolha de uma base com tratamento especial. Ürünün, salinitesi yüksek olan ortamlarda kullanılması durumunda, özel muamele görmüş versiyonun seçilmesi tavsiye olunur. Если изделие будет использоваться в среде с высоким содержанием соли, рекомендуется выбрать основание со специальной обработкой.

BASE SCUDO DOUBLE PIANI 110X170 - 120X80

alluminio

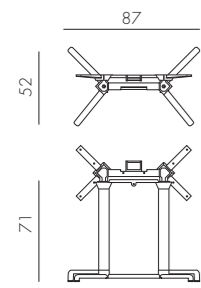

verniciato antracite	verniciato argento	verniciato tortora
54352.00.000	54354.00.000	54359.00.000
■54352.00.000.01	■54354.00.000.01	■54359.00.000.01

8,7 kg
n. pz. 1



BASE CALICE ALU PIANI Ø60 - Ø70 - Ø80 - 60X60 - 70X70 - 80X80

alluminio

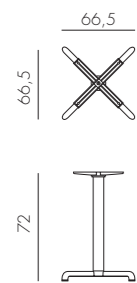

verniciato antracite	verniciato bianco	verniciato argento	verniciato tortora
52652.00.000	52653.00.000	52654.00.000	52659.00.000
■52652.00.000.01	■52653.00.000.01	■52654.00.000.01	■52659.00.000.01

4,5 kg
n. pz. 1

BASE CALICE ALU HIGH PIANI Ø60 - Ø70 - 60X60 - 70X70

alluminio

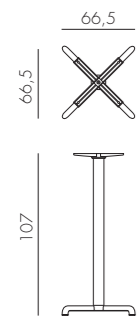

verniciato antracite	verniciato bianco	verniciato argento	verniciato tortora
52752.00.000	52753.00.000	52754.00.000	52759.00.000
■52752.00.000.01	■52753.00.000.01	■52754.00.000.01	■52759.00.000.01

5,5 kg
n. pz. 1

■ trattamento speciale per ambienti ad alto tasso salino - special treatment for high salinity environments - traitement spécial pour les environnements a haute salinité - Sonderbehandlung für Ambiente mit hohem Salzgehalt - tratamiento especial para ambientes con alta salinidad - tratamento especial para ambientes com alto teor de sal - yüksek tuza maruz kalan alanlar için özel bakım - Специальная обработка для среды с высоким содержанием соли

Qualora il prodotto venga posizionato in ambienti altamente salini raccomandiamo di scegliere una base con trattamento speciale. If the product is placed in highly salty environments, we recommend choosing a base with a special treatment. Si le produit est placé dans des environnements a haute salinite, nous recommandons de choisir une base avec un traitement spécial. Wenn das Produkt in der Umgebung mit hohem Salzgehalt platziert ist, empfehlen wir, eine Basis mit Sonderbehandlung zu wählen. Si el producto se coloca en ambientes con alta salinidad, recomendamos elegir una base con un tratamiento especial. Se o produto for exposto em ambientes com alto teor de salinidade, recomendamos a escolha de uma base com tratamento especial. Ürünün, salinitesi yüksek olan ortamlarda kullanılması durumunda, özel muamele görmüş versiyonun seçilmesi tavsiye olunur. Если изделие будет использоваться в среде с высоким содержанием соли, рекомендуется выбрать основание со специальной обработкой.

BASE FLUTE PIANI Ø60 - Ø70

alluminio

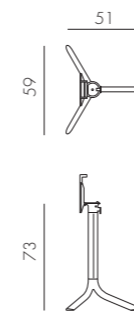

verniciato antracite	verniciato bianco	verniciato argento	verniciato tortora
55652.00.000	55653.00.000	55654.00.000	55659.00.000
■55652.00.000.01	■55653.00.000.01	■55654.00.000.01	■55659.00.000.01

4,9 kg
n. pz. 1



BASE BREAK PIANI Ø60 - Ø70

alluminio

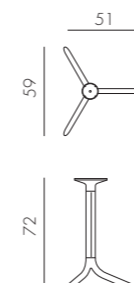















verniciato antracite	verniciato bianco	verniciato argento	verniciato tortora
55852.00.000	55853.00.000	55854.00.000	55859.00.000
■55852.00.000.01	■55853.00.000.01	■55854.00.000.01	■55859.00.000.01

4,3 kg
n. pz. 1

■ trattamento speciale per ambienti ad alto tasso salino - special treatment for high salinity environments - traitement spécial pour les environnements a haute salinité - Sonderbehandlung für Ambiente mit hohem Salzgehalt - tratamiento especial para ambientes con alta salinidad - tratamento especial para ambientes com alto teor de sal - yüksek tuza maruz kalan alanlar için özel bakım - Специальная обработка для среды с высоким содержанием соли

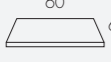
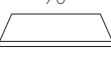
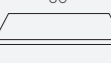
Qualora il prodotto venga posizionato in ambienti altamente salini raccomandiamo di scegliere una base con trattamento speciale. If the product is placed in highly salty environments, we recommend choosing a base with a special treatment. Si le produit est placé dans des environnements a haute salinite, nous recommandons de choisir une base avec un traitement spécial. Wenn das Produkt in der Umgebung mit hohem Salzgehalt platziert ist, empfehlen wir, eine Basis mit Sonderbehandlung zu wählen. Si el producto se coloca en ambientes con alta salinidad, recomendamos elegir una base con un tratamiento especial. Se o produto for exposto em ambientes com alto teor de salinidade, recomendamos a escolha de uma base com tratamento especial. Ürünün, salinitesi yüksek olan ortamlarda kullanılması durumunda, özel muamele görmüş versiyonun seçilmesi tavsiye olunur. Если изделие будет использоваться в среде с высоким содержанием соли, рекомендуется выбрать основание со специальной обработкой.

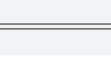







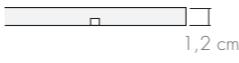

PIANI LAMINATO

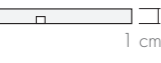
			GRIGIO	BIANCO	CAFFÈ*	ANTRACITE*	CEMENTO	TORTORA
		1,2 cm						
piano Ø60		4,8 kg n. pz. 1	30616.10.300	30616.10.301	30616.10.302	30616.10.303	30616.10.305	30616.10.310
piano Ø70		6,6 kg n. pz. 1	30617.10.300	30617.10.301	30617.10.302	30617.10.303	30617.10.305	30617.10.310
piano Ø80		8,8 kg n. pz. 1	30618.10.300	30618.10.301	30618.10.302	30618.10.303	30618.10.305	30618.10.310
new piano Ø90 ●		11,1 kg n. pz. 1	30619.10.300	30619.10.301	30619.10.302	30619.10.303	30619.10.305	30619.10.310
piano 60x60		6,1 kg n. pz. 1	30606.10.300	30606.10.301	30606.10.302	30606.10.303	30606.10.305	30606.10.310
piano 70x70		8,5 kg n. pz. 1	30607.10.300	30607.10.301	30607.10.302	30607.10.303	30607.10.305	30607.10.310
piano 80x80		11 kg n. pz. 1	30608.10.300	30608.10.301	30608.10.302	30608.10.303	30608.10.305	30608.10.310
new piano 90x90 ●		13,9 kg n. pz. 1	30609.10.300	30609.10.301	30609.10.302	30609.10.303	30609.10.305	30609.10.310
piano 110x70		13,3 kg n. pz. 2	30621.10.300	30621.10.301				
piano 120x80		16,4 kg n. pz. 2	30620.10.300	30620.10.301				

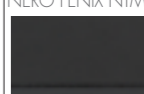
● Solo per Base Frasca Maxi - Only for Base Frasca Maxi - Seulement pour Base Frasca Maxi - Nur für Base Frasca Maxi - Sólo para Base Frasca Maxi - Apenas para Base Frasca Maxi - Sadece Base Frasca Maxi için - Только для Base Frasca Maxi.

* Posizionare in zona d'ombra - Only use table tops in shaded areas - Plateaux qui doivent être utilisés uniquement dans des zones ombragées - Tischplatten nur für beschatteten Einsatzbereich - Utilizar estos tableros sólo en áreas sombreadas - Colocar em local sombreado - Gölge alana koyun - Ставить в тени

PIANI LAMINATO

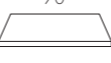
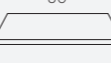
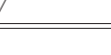
			LEGNO	CORTEN*		TOTAL WHITE	NERO FENIX NTM®	AGAVE new
		1,2 cm						
piano Ø60		4,8 kg n. pz. 1	30616.10.311	30616.10.312	4 kg n. pz. 1			30616.10.316
piano Ø70		6,6 kg n. pz. 1	30617.10.311	30617.10.312	5,5 kg n. pz. 1			30617.10.316
piano Ø80		8,8 kg n. pz. 1	30618.10.311	30618.10.312	7,3 kg n. pz. 1			30618.10.316
new piano Ø90 ●		11,1 kg n. pz. 1	30619.10.311	30619.10.312	9,3 kg n. pz. 1			30619.10.316
piano 60x60		6,1 kg n. pz. 1	30606.10.311	30606.10.312	5 kg n. pz. 1	30606.10.314	30606.10.313	30606.10.316
piano 70x70		8,5 kg n. pz. 1	30607.10.311	30607.10.312	6,8 kg n. pz. 1	30607.10.314	30607.10.313	30607.10.316
piano 80x80		11 kg n. pz. 1	30608.10.311	30608.10.312	9,2 kg n. pz. 1	30608.10.314	30608.10.313	30608.10.316
new piano 90x90 ●		13,9 kg n. pz. 1	30609.10.311	30609.10.312	11,6 kg n. pz. 1	30609.10.314	30609.10.313	30609.10.316

PIANI DURELTOP

BASE CALICE - SCUDO - IBISCO - FIORE - BASE CLIP

			BIANCO	ANTRACITE*	GRIGIO	CAFFÈ*	TORTORA
							
piano 70x70		sp. 2,2 cm 3,9 kg n. pz. 1	30207.00.400	30207.00.402	30207.00.403	30207.00.405	30207.00.410
piano 80x80		sp. 3,2 cm 7,2 kg n. pz. 1	30208.00.400	30208.00.402	30208.00.403	30208.00.405	30208.00.410

● Solo per Base Frasca Maxi - Only for Base Frasca Maxi - Seulement pour Base Frasca Maxi - Nur für Base Frasca Maxi - Sólo para Base Frasca Maxi - Apenas para Base Frasca Maxi - Sadece Base Frasca Maxi için - Только для Base Frasca Maxi.

* Posizionare in zona d'ombra - Only use table tops in shaded areas - Plateaux qui doivent être utilisés uniquement dans des zones ombragées - Tischplatten nur für beschatteten Einsatzbereich - Utilizar estos tableros sólo en áreas sombreadas - Colocar em local sombreado - Gölge alana koyun - Ставить в тени

CUSCINO NET BENCH

tessuto

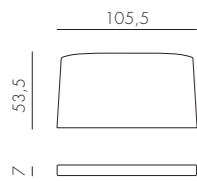

1,5 kg
n. pz. 4

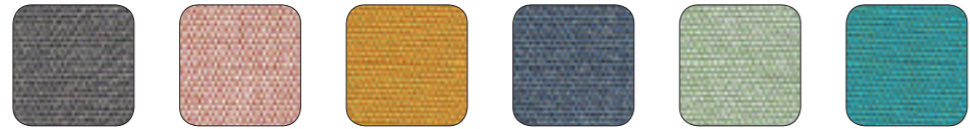

grey stone 36338.00.064
rosa quarzo 36338.00.066
senape 36338.00.069
denim 36338.00.070
the verde 36338.00.071
sardinia 36338.00.072



bianco 36338.00.155
grigio 36338.00.163
grigio Sunbrella® 36338.00.136

CUSCINO NET RELAX

tessuto

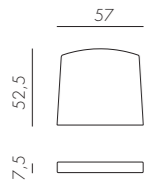

0,8 kg
n. pz. 4

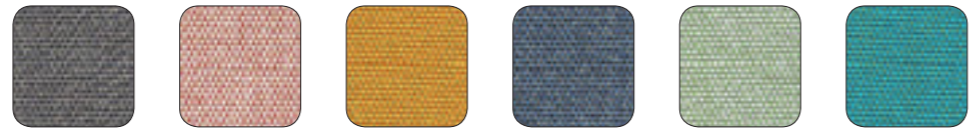

grey stone 36327.00.064
rosa quarzo 36327.00.066
senape 36327.00.069
denim 36327.00.070
the verde 36327.00.071
sardinia 36327.00.072



bianco 36327.00.155
grigio 36327.00.163
grigio Sunbrella® 36327.00.136

CUSCINO SHELL (NET RELAX)

tessuto

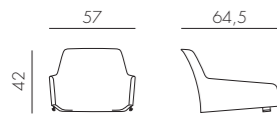

2,2 kg
n. pz. 2



rosa quarzo 36327.01.066
denim 36327.01.070
grigio 36327.01.163

Utilizzabile solo con cuscino Net Relax - Can only be used with Net Relax cushion - À utiliser uniquement avec le coussin Net Relax - Kann nur mit Net Relax Kissen verwendet werden - Se puede utilizar sólo con el cojín Net Relax - Só pode ser usada em conjunto com almofada de assento Net Relax - Sadece Net Relax minderiyile kullanılmali - Можно использовать только с подушкой Net Relax.

CUSCINO NET

tessuto



0,3 kg
n. pz. 4

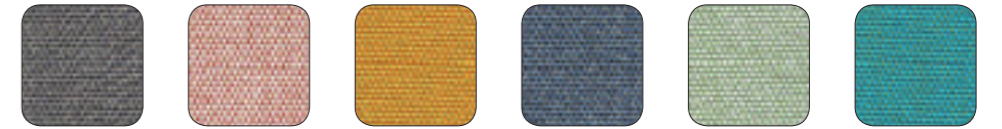

grey stone 36326.00.064
rosa quarzo 36326.00.066
senape 36326.00.069
denim 36326.00.070
the verde 36326.00.071
sardinia 36326.00.072



bianco 36326.00.155
grigio 36326.00.163
grigio Sunbrella® 36326.00.136

CUSCINO TRILL

tessuto

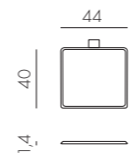

0,2 kg
n. pz. 4



cenere 36253.00.132

Solo per sedia Trill Bistrot - Only for Trill Bistrot chair - Seulement pour la chaise Trill Bistrot - Nur für Trill Bistrot Stuhl - Sólo para silla Trill Bistrot - Apenas para cadeira Trill Bistrot - Sadece Trill Bistrot sandalyesi için - Только для кресла Trill Bistrot.

CUSCINO PASSEPARTOUT

tessuto

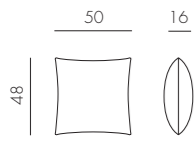

0,7 kg
n. pz. 4

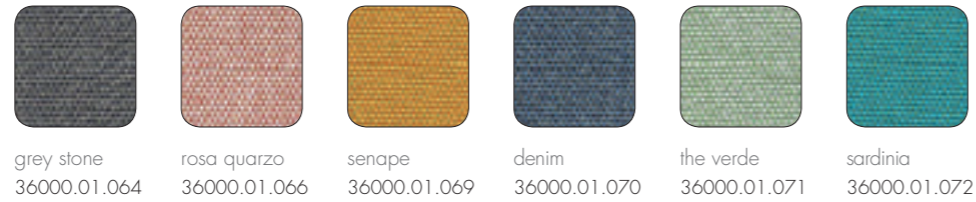

CUSCINO RETTANGOLARE **new**

tessuto

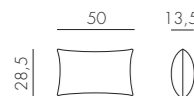

0,55 kg
n. pz. 4



CUSCINO ACQUAMARINA

tessuto

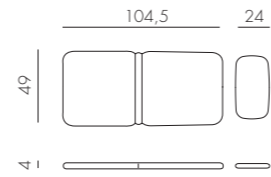

0,9 kg
n. pz. 4



CUSCINO DARSENA

tessuto

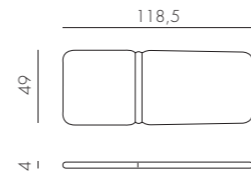

0,8 kg
n. pz. 4



CUSCINO EDEN

tessuto

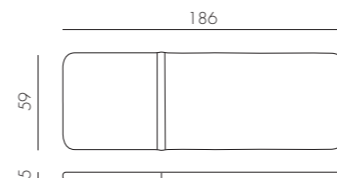

1,8 kg
n. pz. 4



CLEAN RESIN SPECIAL

detergente 5 L

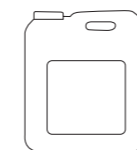

5,5 kg
n. pz. 1

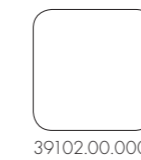

Detergente specifico per la pulizia dei lettini Alfa, Omega e Atlantico
Detergent specific for the cleaning of our sunloungers Alfa, Omega and Atlantico
Détergent spécifique pour nettoyer nos lits Alpha, Omega et Atlantico
Reinigungsmittel speziell geeignet für die Reinigung unserer Liegen Alpha, Omega und Atlantico
Detergente para la limpieza de nuestra camas Alfa, Omega y Atlantico
Detergente para a limpeza de nossas camas Alpha, Omega e Atlantico
Alfa ve Omega ve Atlantico kumaşı için özel sıvı deterjan
Специальное моющее средство для лежаков алфа и omega и atlantico

materiali
materials

polipropilene

Polipropilene trattato anti-UV e colorato in massa. Riciclabile al 100%.
Polypropylene with UV additives and is uniformly colored. 100% Recyclable resin.
Polypropylène traité anti-UV et coloré dans la masse. Résine recyclable 100%.
UV-beständigem Polypropylen, voll durchgefärbt. 100% Recyclebarer Kunststoff.
Polipropileno tratado anti UV y teñido en masa. Resina reciclable 100%.
Polipropileno com tratamento anti-UV colorido na totalidade. Resina reciclável 100%.
Işığa dayanıklı ve boyalı olarak granül çekilmiş %100 geri dönüşümlü polipropilen kompozit hammadde.
Полипропилен с обработкой анти-УФ, окрашенное в массу. На 100% пригодно для вторичной переработки.

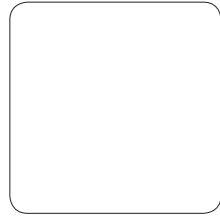

BIANCO .00



GRIGIO .03



ANTRACITE .02



BURRO .28



TORTORA .10



TABACCO .53



CAFFE' .05



CELESTE .39



OTTANIO .49



SALICE .04



AGAVE .16



SENAPE .56

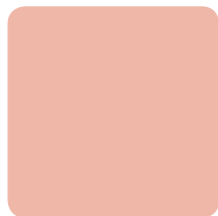

ROSA BOUQUET .08



CORALLO .75



ROSSO .07

polipropilene fiberglass

Polipropilene fiberglass trattato anti-UV e colorato in massa. Resina riciclabile al 100%.
Uniformly colored fiberglass polypropylene resins with uv additives. 100% Recyclable resin.
Polypropylène fiberglass traité anti-uv et coloré dans la masse. Résine recyclable 100%.
UV-beständigem fiberglass Polypropylen, voll durchgefärbt. 100% Recyclebarer Kunststoff.
Polipropileno fiberglass tratado anti UV y teñido en masa. Resina reciclable 100%.
Polipropileno fiberglass com tratamento anti-UV colorido na totalidade. Resina reciclável 100%.
Işığa dayanıklı ve boyalı olarak granül çekilmiş %100 geri dönüşümlü cam elyaf katkılı polipropilen kompozit hammadde.
Полипропилен фиброволокно с обработкой анти-УФ, окрашенное в массу. На 100% пригодно для вторичной переработки.

polipropilene fiberglass rigenerato

Polipropilene fiberglass rigenerato trattato anti-UV e colorato in massa. Resina riciclabile al 100%.
Regenerated uniformly colored fiberglass polypropylene resins with UV additives. 100% Recyclable resin.
Polypropylène fiberglass régénérée traité anti-UV et coloré dans la masse. Résine recyclable 100%.
Regeneriertem UV-beständigem fiberglass-Polypropylen, voll durchgefärbt. 100% Recyclebarer Kunststoff.



TERRA .44

Polipropileno fiberglass regenerado tratado anti-UV y teñido en masa. Resina reciclable 100%.
Polipropileno fiberglass regenerado com tratamento anti-UV colorido na totalidade. Resina reciclável 100%.
Uv katlı maddeleriyle fiberglass polipropilen reçine ile renklendirilip düzgün bir şekilde tekrar oluşturulmuştur.
Переработанный, крашенный, полипропилен fiberglass обработанный против проникновения ультрафиолетовых лучей. На 100% пригодно для вторичной переработки.

durelTOP

DurelTOP è un sistema innovativo di produzione di piani per tavoli studiati per raggiungere i più elevati livelli di praticità, resistenza, robustezza ed eleganza. I piani DurelTOP sono ad alto spessore, formati da un doppio strato tamburato perfettamente chiuso. Prodotti in polipropilene di prima qualità, sono inalterabili all'acqua, resistenti al sole e facili da pulire. DurelTOP è il risultato di una lunga ricerca tecnologica e dell'esperienza decennale nella lavorazione delle materie plastiche della NARDI, da sempre all'avanguardia nell'ambiente contract e giardino.

The DurelTOP is an innovative new system in the production of tabletops developed to reach the highest levels of practicality, resistance, and elegance. The DurelTOP tabletops have a greater thickness, formed by a double layer enclosure perfectly closed. Produced in first quality polypropylene, they are resistant to water, resistant to sunlight, and are easy to clean. DurelTOP is a result of a decade's long research and development in plastics by Nardi, always a leader in the contract and garden sectors.

DurelTOP est un système innovateur de production de plateaux de tables, il est étudié pour retrouver le meilleur niveau de pratique de résistance et d'élégance. Les plateaux DurelTOP sont très épais, formés de doubles couches parfaitement finies. Ce sont des produits en polypropylène de première qualité, ils sont inaltérables à l'eau, résistent au soleil et faciles à nettoyer. DurelTOP est le résultat d'une longue recherche technologique et une expérience décennale dans le travail des matières plastique de la Sté NARDI, toujours à l'avant-garde dans le secteur du contract et jardin.

DurelTOP ist ein neu entwickeltes System für die Produktion von Tischplatten, um ein Höchstmaß an Funktionalität, Widerstandsfähigkeit und Eleganz zu erreichen. Durch das innen verstärkte "Zwei-Schichten-Hohlraum-System" erreicht die DurelTOP Tischplatte einen stärkeren Querschnitt und damit ein Höchstmaß an Festigkeit. Hergestellt aus hochwertigem Qualitätspolypropylen ist sie resistent gegen Wasser und Sonnenlicht und dabei leicht zu reinigen. DurelTOP ist das Ergebnis von 10 Jahren Forschung und Entwicklung auf dem Kunststoffsektor durch Nardi, immer der führende im Bereich Contract und Gartenmöbel.

DurelTOP es un nuevo sistema de fabricación de tableros de mesa estudiado para alcanzar los mas altos niveles de practicidad, resistencia, robustez y elegancia. Los tableros DurelTOP de gran solidez, estan formados por una doble capa perfectamente unida y sellada. Fabricados en polipropileno de primera calidad son inalterables al agua, resistentes al sol y de fácil limpieza. DurelTOP es el resultado de una prolongada investigación tecnológica y de la experiencia acumulada en los mas de diez años que Nardi lleva produciendo materias plasticas, siempre innovando en ambientes contract y jardin.

DurelTOP é um sistema de inovação da produção de tampos de mesa concebidos para atingir a máxima resistência,práticos e elegantes. Os tampos de mesa DurelTOP são formados por uma camada dupla e perfeitamente unida. Produzidos em polipropileno de primeira qualidade, são resistentes ao sol e fáceis de limpar. DurelTOP é o resultado de uma longa investigação tecnológica em materiais plásticos da Nardi, leader em mobiliário de jardim.

DurelTOP, masa tablalarının üretiminde kullanılan yeni bir sistem olup, yüksek seviyede pratiklik, direnç ve de şıklık sunmak amacıyla geliştirilmiştir. DurelTOP masa tablaları fevkalade bir inceliğe sahip olup, kusursuz kapanan çift tabaka çevirme sistemiyle oluşturulmuştur. Nitelikli çamşaklı zından üretilmiş olup, suya ve güneş ışığına karşı dirençli ve temizlenmesi kolaydır. DurelTOP sistemini Contract ve de Bahçe sektöründe her zaman lider olan Nardi'nin uzun araştırmalarının sonucundan doğan, plastikte gelişim olarak adlandırabiliriz.

DurelTOP — это инновационная система производства столешниц, позволяющая изготавливать практичные, прочные, крепкие и элегантные столешницы. Столешницы DurelTOP обладают высокой плотностью и состоят из двойной панели с мелкопустотным наполнением, полностью закрытой. Изделия из полипропилен высокого качества устойчивы к воде, солнцу и просты в уходе. DurelTOP — это результат многолетних технологических исследований и десятилетнего опыта NARDI в обработке пластмасс, лидера в производстве садовой мебели и контрактном секторе.



tessuto acrilico



Fibra acrilica 100% tinto filo. Trattamento antimacchia, antimuffa. Solidità alla luce 5/8. Sfoderabile/zip, lavabile a 30°.
100% yarn dyed acrylic. Dirt repellent and anti-mould treatment. 5/8 light fastness. Removeable/zip, washable at 30°.
100% fibre acrylique teintée en fils. Traitement anti-taches et anti-moisissure. Résistance à la lumière 5/8. Déhoussable/zip. Lavable à 30°.
100% garngefärbtes Polyacryl Gewebe. Gegen Flecken und Schimmel Ausrüstung. Lichtechtheit 5/8. Abziehbarer/zip. Waschbar bei 30°.

100% hilo teñido acrílico. Protección antimanchas, antimoho. Solidez a la luz 5/8. Desenfundable/zip. Lavable a 30°.
100% fibra acrílica tingida com fio. Tratamento antimancha e antimoho. Resistência à luz 5/8. Removível/zip. Lavável a 30°.
%100 akrilik elyaf boyalı iplik. Leke itici, küf önleyici ile muamele edilmiş. Işık haslığı 5/8. Çıkarılabilir/fermuar, 30°de yıkanabilir.
Акриловое волокно 100% окрашенное в пряде. Пятноустойчивая и противогрибковая обработка. Светостойкость 5/8. Съемная обивка/с молнией, стирать при 30°.



grigio .163
240 gr/m²



grey stone .064
240 gr/m²



the verde .071
240 gr/m²

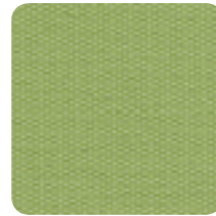

lime .061
240 gr/m²



sardinia .072
240 gr/m²



denim .070
240 gr/m²



rosa quarzo .066
240 gr/m²



senape .069
240 gr/m²



cherry .065
240 gr/m²

tessuto acrilico stampato



Fibra acrilica 100% stampa digitale. Solidità alla luce 6. Sfoderabile/zip, lavabile a 30°.
100% acrylic fiber with digital print. 6 light fastness. Removeable/zip, washable at 30°.
100% fibre acrylique impression numérique. Résistance à la lumière 6. Déhoussable/zip. Lavable à 30°.
100% Polyacrylfaser mit Digitaldruck. Lichtechtheit 6. Abziehbarer/zip. Waschbar bei 30°.

100% fibra acrílica impresión digital. Solidez a la luz 6. Desenfundable/zip. Lavable a 30°.
100% fibra acrílica estampa digital. Resistência à luz 6. Removível/zip. Lavável a 30°.
%100 dijital baskı akrilik elyaf. Işığa dayanıklılık 6. Çıkarılabilir kılıf/fermuar, 30°de yıkanabilir.
100% акриловое волокно с цифровым рисунком, окрашенное в процессе производства. Светостойкость 6. Съемная ткань/на молнии, стирка при 30°.



tropical .081
190 gr/m²

tessuto acrilico Sunbrella®



100% fibra acrilica SUNBRELLA® tinto in massa. Trattamento idrorepellente, antimacchia, antimuffa. Solidità alla luce 8/8. Sfoderabile/zip, lavabile a 40°.
100% SUNBRELLA® acrylic fiber mass dyed. Water repellent treatment, dirt repellent and anti-mould treatment. 8/8 light fastness. Removeable/zip, washable at 40°.
100% fibre acrylique SUNBRELLA® teintée en masse. Traitement imperméable, anti-taches et anti-moisissure. Résistance à la lumière 8/8. Déhoussable/zip. Lavable à 40°.
100% fasergefärbtes SUNBRELLA® Polyacryl. Wasserabweisend Ausrüstung, gegen Flecken und Schimmel ausgerüstet. Lichtechtheit 8/8. Abziehbarer/zip. Waschbar bei 40°.

100% fibra acrílica SUNBRELLA® tintada en masa. Tratamiento por la repelencia al agua, protección antimanchas, antimoho. Solidez a la luz 8/8. Desenfundable/zip. Lavable a 40°.
100% fibra acrílica SUNBRELLA® tingida em massa. Tratamento hidrorrepelente, antimancha e antimoho. Resistência à luz 8/8. Removível/zip. Lavável a 40°.
%100 akrilik elyaf SUNBRELLA® çözelti halindeyken boyanmış. Su itici, leke itici, küf önleyici ile muamele edilmiş. Işık haslığı 8/8. Çıkarılabilir/fermuar, 40°de yıkanabilir.
100% акриловое волокно SUNBRELLA®, окрашенное в массе. Водоотталкивающая, пятноустойчивая и противогрибковая обработка. Светостойкость 8/8. Съемная обивка/с молнией, стирать при 40°.

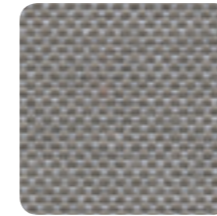

grigio Sunbrella® .136
275 gr/m²

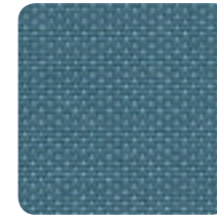

adriatic Sunbrella® .142
260 gr/m²

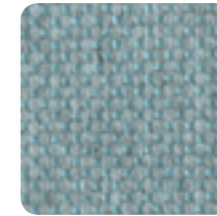

ghiaccio Sunbrella® .138
275 gr/m²

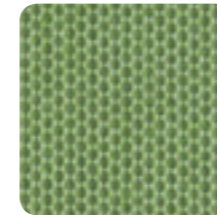

avocado Sunbrella® .139
260 gr/m²

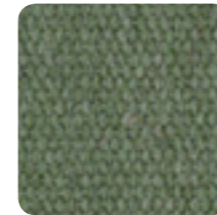

giungla Sunbrella® .140 ✱
340 gr/m²

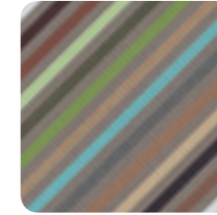

rigato Sunbrella® .171
260 gr/m²

✱ 50% fibra acrilica SUNBRELLA® riciclata tinto in massa, 47% fibra acrilica SUNBRELLA® tinto in massa, 3% poliester.
50% blended SUNBRELLA® acrylic fiber mass dyed, 47% SUNBRELLA® acrylic fiber mass dyed, 3% polyester.
50% fibre acrylique SUNBRELLA® recyclée teintée en masse, 47% fibre acrylique SUNBRELLA® teintée en masse, 3% de polyester.
50% fasergefärbtes, recyceltes SUNBRELLA® Polyacryl, 47% fasergefärbtes SUNBRELLA® Polyacryl, 3% Polyester.
50% fibra acrílica SUNBRELLA® reciclada tintada en masa, 47% fibra acrílica SUNBRELLA® tintada en masa, 3% poliéster.
50% fibra acrílica SUNBRELLA® reciclada tingida em massa, 47% fibra acrílica SUNBRELLA® tingida em massa, 3% de poliéster.
%50 geri dönüştürülmüş akrilik elyaf SUNBRELLA® çözelti halindeyken boyanmış, %47 akrilik elyaf SUNBRELLA® çözelti halindeyken boyanmış, %3 polyester.
50% переработанное акриловое волокно SUNBRELLA®, окрашенное в массе, 47% акриловое волокно SUNBRELLA®, окрашенное в массе, 3% полиэстер.

tessuto acrilico Sunbrella® laminato



100% fibra acrilica SUNBRELLA® tinto in massa. Trattamento idrorepellente, antimacchia, antimuffa. Solidità alla luce 8/8. Accoppiato internamente con un film in poliuretano che lo rende impermeabile. Sfoderabile/zip, lavabile a 30°. La parte accoppiata in poliuretano non deve essere esposta al sole.

100% SUNBRELLA® acrylic fiber mass dyed. Water repellent treatment, dirt repellent and anti-mould treatment. 8/8 light fastness. Bonded with a polyurethane film that makes it water proof. Removeable/zip, washable at 30°. The polyurethane laminated surface should not be exposed to direct sunlight.

100% fibre acrylique SUNBRELLA® teintée en masse. Traitement imperméable, anti-taches et anti-moisissure. Résistance à la lumière 8/8. Doublé en interne avec un film de polyuréthane qui le rend imperméable. Déhoussable/zip. Lavable à 30°. La partie en polyuréthane ne doit pas être exposée au soleil.

100% fasergefärbtes SUNBRELLA® Polyacryl. Wasserabweisend Ausrüstung, gegen Flecken und Schimmel ausgerüstet. Lichtechtheit 8/8. Innen mit einer Polyurethanfolie verbunden, die es wasserdicht macht. Abziehbarer/zip. Waschbar bei 30°. Das mit Polyurethan verbundene Teil darf nicht der Sonne ausgesetzt werden.



canvas Sunbrella® laminato .170 ●
275 gr/m²

TECH



50% vinile e 50% poliestere. Trattamento idrorepellente, antimacchia, antimuffa, ignifugo e antibatterico. Solidità alla luce 6. Sfoderabile/zip. Lavare a mano in acqua fredda.

50% vinyl and 50% polyester. The treatment makes the coating: water repellent, and resistant to staining, resistant to mold, fire retardant, and antibacterial. 6 light fastness. Removeable/zip. Hand wash in cold water.

50% vinyle et 50% polyester. Traitement imperméable, anti-taches, anti-moisissures, ignifugé et antibactérien. Résistance à la lumière 6. Déhoussable/zip. Laver à la main à l'eau froide.

50% Vinyl und 50% Polyester. Wasserabweisend, gegen Flecken und Schimmelbildung ausgerüstet, feuerfest und antibakteriell. Lichtechtheit 6. Abziehbarer/zip. Handwäsche in kaltem Wasser.



TECH panama .131 ●
830 gr/m²

- Alla base dei cuscini seduta comodo canvas Sunbrella® laminato e TECH panama viene applicata una rete a maglia larga in poliestere per permettere la traspirazione. At the bottom of the Komodo seat cushions, made with canvas Sunbrella® laminato and TECH panama, the fabric is a polyester wide mesh to allow breathability. À la base des coussins d'assise comodo canvas Sunbrella® laminato and TECH panama, un filet de polyester à larges mailles est appliqué pour évacuer la transpiration. Auf der Unterseite der canvas Sunbrella® laminato und TECH panama Komodo-Sitzkissen ist ein atmungsaktives Polyesternetz mit großer Maschenweite angebracht, um Luftaustausch zu ermöglichen. En la base de los cojines de asiento del comodo canvas Sunbrella® laminato y TECH panama, se aplica una red de poliéster de malla ancha para permitir la transpiración. Na base das almofadas do assento de comodo canvas Sunbrella® laminato e TECH panama, é aplicada uma tela de poliéster de malha larga para permitir a transpiração. Hava alması için Komodo'nun altında canvas Sunbrella® laminato, TECH panama minderle, geniş fileli polyester uygulanmıştır.

в основе подушек comodo ламинированный материал canvas Sunbrella и Tech panama добавлена сетка с широкой вязкой из полиэстера, чтобы материал проветривался.

tessuto 100% Olefin



100% Olefin tinto in massa. Trattamento antimacchia, antimuffa. Solidità alla luce 7/8. Sfoderabile/zip, lavabile a 40°.

100% Olefin mass dyed. Dirt repellent and anti-mould treatment. 7/8 light fastness. Removeable/zip, washable at 40°.

100% Olefin teintée en masse. Traitement anti-taches et anti-moisissure. Résistance à la lumière 7/8. Déhoussable/zip. Lavable à 40°.

100% fasergefärbtes Olefin. Gegen Flecken und Schimmel Ausrüstung. Lichtechtheit 7/8. Abziehbarer/zip. Waschbar bei 40°.

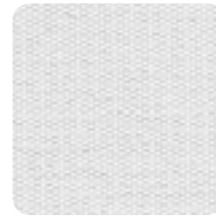

bianco .155
190 gr/m²



caffè .165
190 gr/m²

100% Olefin tintada en masa. Protección antimanchas, antimoho. Solidez a la luz 7/8. Desfundable/zip. Lavable a 40°.

100% Olefin tingida em massa. Tratamento antimancha e antimoho. Resistência à luz 7/8. Removível/zip. Lavável a 40°.

%100 Olefin çözelti halindeyken boyanmış. Leke itici, küf önleyici ile muamele edilmiş. Işık haslığı 7/8. Çıkarılabilir/fermuar, 40°de yıkanabilir.

100% Olefin, окрашенный в массе. Пятноустойчивая и противогрибковая обработка. Светостойкость 7/8. Съемная обивка/с молнией, стирать при 40°.

tessuto 100% Olefin idrorepellente



100% Olefin tinto in massa. Trattamento con resina poliuretanica/acrilica, idrorepellente. Solidità alla luce 7/8. Sfoderabile/zip, lavabile a 40°.

100% Olefin mass dyed. Treatment with polyurethane/acrylic resin, water-repellent. 7/8 light fastness. Removeable/zip, washable at 40°.

100% Olefin teintée en masse. Traitement avec une résine de polyuréthane acrylique, imperméable. Résistance à la lumière 7/8. Déhoussable/zip. Lavable à 40°.

100% fasergefärbtes Olefin. Ausrüstung mit Polyurethan-Harz/Polyacryl, wasserabweisend. Lichtechtheit 7/8. Abziehbarer/zip. Waschbar bei 40°.

100% Olefin tintada en masa. Tratamiento con resina de poliuretano/acrílica, repelente al agua. Solidez a la luz 7/8. Desfundable/zip. Lavable a 40°.

100% Olefin tingida em massa. Tratamento com resina de poliuretano acrílico, hidropelente. Resistência à luz 7/8. Removível/zip. Lavável a 40°.

100% Olefin çözelti halindeyken boyanmış. Poliüretan reçine/akrilik ile muamele edilmiş, su itici. Işık haslığı 7/8. Çıkarılabilir/fermuar, 40°de yıkanabilir.

100% Olefin, окрашенный в массе. Обработка полиуретановым/акриловым полимером, водоотталкивающая. Светостойкость 7/8. Съемная обивка/с молнией, стирать при 40°.



écru .160
220 gr/m²



blu .076
220 gr/m²

cuscino Trill termoformato



TESSUTO SUNBRELLA® TERRY: 76% fibra acrilica SUNBRELLA® tinto in massa e 24% poliestere. Trattamento antimacchia, antimuffa. Solidità alla luce 7/8. Senza cuciture. Lavabile a 30°. Imbottitura: poliuretano espanso rivestito da una membrana TPU waterproof. Densità 40 kg/m³. SUNBRELLA® TERRY FABRIC: 76% SUNBRELLA® acrylic fiber mass dyed and 24% polyester. Dirt repellent and anti-mould treatment. 7/8 light fastness. Seamless. Washable at 30°. Padding: polyurethane foam with a TPU waterproof membrane coating. Density 40 kg/m³. SUNBRELLA® TERRY TISSU :76% fibre acrylique SUNBRELLA® teintée en masse et 24% polyester. Traitement anti-taches et anti-moisissure. Résistance à la lumière 7/8. Sans couture. Lavable à 30°. Rembourrage: mousse polyuréthane revêtu d'une membrane TPU imperméable. Densité 40 kg/m³. SUNBRELLA® TERRY GEWEBE: 76% fasergefärbtes Polyacryl SUNBRELLA® und 24% Polyester. Gegen Flecken und Schimmel Ausrüstung. Lichtechtheit 7/8. Ohne Nähte. Waschbar bei 30°. Polsterung: Polyurethanschäum mit einer wasserdichten TPU-Membran abgedeckt. Dichte 40 kg/m³.



cenere .132
550 gr/m²

TEJIDO SUNBRELLA® TERRY: 76% fibra acrílica SUNBRELLA® tintada en masa y 24% poliéster. Protección antimanchas, antimoho. Solidez a la luz 7/8. Sin costuras. Lavable a 30°. Relleno: espuma de poliuretano recubierto con una membrana de TPU impermeable. Densidad 40 kg/m³. TECIDO SUNBRELLA® TERRY: 76% fibra acrílica SUNBRELLA® tingida em massa e 24% poliéster. Tratamento antimancha e antimofa. Resistência à luz 7/8. Sem costuras. Lavável a 30°. Enchimento: espuma de poliuretano com cobertura de membrana TPU impermeável. Densidade 40 kg/m³. SUNBRELLA® TERRY KUMAŞ: %76 akrilik elyaf SUNBRELLA® çözüli halindeyken boyanmış ve %24 polyester. Leke itici, küf önleyici ile muamele edilmiş. Işık haslığı 7/8. Dikişsiz. 30°de yıkanabilir. Dolgu malzemesi: TPU waterproof film ile kaplanmış poliüretan köpük. Yoğunluk 40 kg/m³. ТКАНЬ SUNBRELLA® TERRY: 76% акриловое волокно SUNBRELLA®, окрашенное в массе и 24% полиэстера. Пятноустойчивая и противоплесневая обработка. Светостойкость 7/8. Без швов. Стирать при 30°. Набивка: пенополиуретан с покрытием из водостойкой мембраны ТПУ. Плотность 40 кг/м³.

imbottitura

CUSCINO NET BENCH - CUSCINO NET RELAX - CUSCINO NET - CUSCINO FIT ARIA - CUSCINO ACQUAMARINA - CUSCINO DARSENA

Poliuretano espanso. Densità 28 kg/m³. Polyurethane foam. Density 28 kg/m³. Mousse polyuréthane. Densité 28 kg/m³. Polyurethanschäum. Dichte 28 kg/m³. Espuma de poliuretano. Densidad 28 kg/m³. Espuma de poliuretano. Densidade 28 kg/m³. Poliüretan köpük. Yoğunluk 28 kg/m³. Пенополиуретан. Плотность 28 кг/м³.

CUSCINO SEDUTA ARIA

Poliuretano espanso. Densità 25 kg/m³. Polyurethane foam. Density 25 kg/m³. Mousse polyuréthane. Densité 25 kg/m³. Polyurethanschäum. Dichte 25 kg/m³. Espuma de poliuretano. Densidad 25 kg/m³. Espuma de poliuretano. Densidade 25 kg/m³. Poliüretan köpük. Yoğunluk 25 kg/m³. Пенополиуретан. Плотность 25 кг/м³.

CUSCINO SHELL NET RELAX

Poliuretano espanso su struttura rigida di polipropilene. Densità 70 kg/m³. Polyurethane foam over solid polypropylene frame. Density 70 kg/m³. Mousse polyuréthane sur structure rigide de polypropylène. Densité 70 kg/m³. Polyurethanschäum auf steifer Polypropylen-gestell. Dichte 70 kg/m³. Espuma de poliuretano sobre estructura rígida de polipropileno. Densidad 70 kg/m³. Espuma de poliuretano sobre estrutura rígida de polipropileno. Densidade 70 kg/m³. Sert polipropilen gövde üzerinde poliüretan köpük minder. Yoğunluk 70 kg/m³. Пенополиуретан. на жесткой конструкции из полипропилена. Плотность 70 кг/м³.

CUSCINO PASSEPARTOUT - CUSCINO RETTANGOLARE

Fibra di poliestere. Polyester fiber. Fibre de polyester. Polyesterfasern. Fibras de poliéster. Fibras de poliéster. Polyester elyaf. Обивка из полиэстера.

CUSCINO SEDUTA KOMODO - CUSCINO ARREDO ARIA

Poliuretano espanso (densità 25 kg/m³) rivestito da fibra di poliestere (densità 450 gr/m²). Polyurethane foam (density 25 kg/m³) with a polyester fiber coating (density 450 gr/m²). Mousse polyuréthane (densité 25 kg/m³) revêtu de fibre de polyester (densité 450 gr/m²). Polyurethanschäum (Dichte 25 kg/m³) mit Polyesterfasern beschichtet (Dichte 450 gr/m²). Espuma de poliuretano (densidad 25 kg/m³) cubierta con fibras de poliéster (densidad 450 gr/m²). Espuma de poliuretano (densidade 25 kg/m³) com cobertura fibras de poliéster (densidade 450 gr/m²). Polyester elyaf (Yoğunluk 450 gr/m²) kaplı köpük poliüretan (Yoğunluk 25 kg/m³). Пенополиуретан (Плотность 25 кг/м³) с покрытием из обивка из полиэстера (Плотность 450 гр/м²).

CUSCINO SCHIENALE KOMODO - CUSCINO SCHIENALE ANGOLO KOMODO

Poliuretano espanso (densità 21 kg/m³) rivestito da fibra di poliestere (densità 450 gr/m²). Polyurethane foam (density 21 kg/m³) with a polyester fiber coating (density 450 gr/m²). Mousse polyuréthane (densité 21 kg/m³) revêtu de fibre de polyester (densité 450 gr/m²). Polyurethanschäum (Dichte 21 kg/m³) mit Polyesterfasern beschichtet (Dichte 450 gr/m²). Espuma de poliuretano (densidad 21 kg/m³) cubierta con fibras de poliéster (densidad 450 gr/m²). Espuma de poliuretano (densidade 21 kg/m³) com cobertura fibras de poliéster (densidade 450 gr/m²). Polyester elyaf (Yoğunluk 450 gr/m²) kaplı köpük poliüretan (Yoğunluk 21 kg/m³). Пенополиуретан (Плотность 21 кг/м³) с покрытием из обивка из полиэстера (Плотность 450 гр/м²).

CUSCINO EDEN

Poliuretano espanso. Densità 18 kg/m³. Polyurethane foam. Density 18 kg/m³. Mousse polyuréthane. Densité 18 kg/m³. Polyurethanschäum. Dichte 18 kg/m³. Espuma de poliuretano. Densidad 18 kg/m³. Espuma de poliuretano. Densidade 18 kg/m³. Poliüretan köpük. Yoğunluk 18 kg/m³. Пенополиуретан. Плотность 18 кг/м³.

tessuto sintetico

Tessuto in filo di poliestere rivestito in pvc. Fabric is made of a polyester fiber, with a pvc coating. Tissu en fil de polyester revêtu de pvc. Gewebe aus PVC-ummantelten Polyesterfasern.

Tejido en hilo de poliester recubierto de pvc. Tecido de fibra polyester com cobertura pvc. PVC kaplı polyester elyaf tekstil. Ткань из полиэфирных нитей с покрытием из ПВХ.

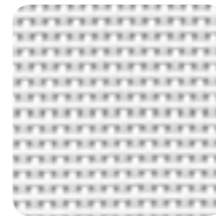

bianco .107
tela 1x1

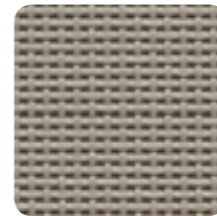

tortora .104
tela 1x1

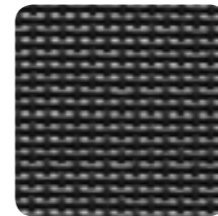

antracite .057
tela 1x1

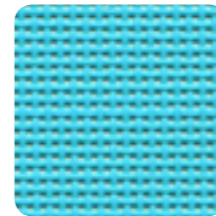

celeste .075
tela 1x1

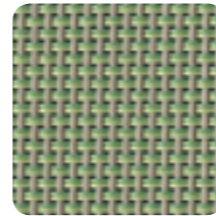

agave .101
tela 2x1

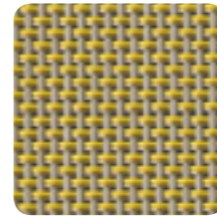

deserto .103
tela 2x1



bianco .108
tela 2x2

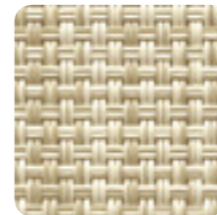

beige .115
tela 2x2



tortora .124
tela 2x2



blu .112
tela 2x2



grigio .086
tela 2x2



trama caffè .117

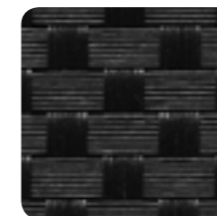

trama antracite .116

alluminio

verniciato

La verniciatura è a polvere di poliester. The painting is with polyester powder.
La peinture est à poudre de polyester. Die Epoxierung erfolgt mit Polyesterpulver. El pintado

se realiza con polvo de poliéster. O pó de poliéster é usado para envernizar. Boyası polyester tozla yapılır. Окраска производится при помощи порошкового полиэстера.

verniciato - trattamento speciale

Trattamento speciale per ambienti ad alto tasso salino. Special treatment for high salinity environments. Traitement spécial pour les environnements a haute salinité. Sonderbehandlung für Ambiente mit hohem Salzgehalt. Tratamiento especial para ambientes con alta

salinidad. Tratamento especial para ambientes com alto teor de sal. Yüksek tuza maruz kalan alanlar için özel bakım. Специальная обработка для среды с высоким содержанием соли.



verniciato bianco .53



verniciato burro .58



verniciato argento .54



verniciato tortora .59



verniciato caffè .57



verniciato antracite .52



verniciato agave .66

laminato HPL

Laminato decorativo ad alta pressione, compatto, omogeneo, non poroso, ad alta densità. Decorative high pressure laminate, solid, homogeneous, non-porous and with a high density. Stratifié décoratif à haute pression, condensé, homogène, pas poreux, haute densité. HPL-Laminat, beständig, homogen, hoch verdichtet. Laminado decorado a alta presión, compacto, homogéneo, no poroso y de alta densidad.

Decorativo e laminado a alta pressão, sólido, homogêneo, não poroso e de grande densidade. Dekoratif yüksek basınçlı laminat, masif, gözeneksiz ve yüksek yoğunluklu. Декоративный ламинат высокого давления, компактный, однородный, непористый, с высокой плотностью.



BIANCO .301
sp. 12 mm



GRIGIO .300
sp. 12 mm



CEMENTO .305
sp. 12 mm



TORTORA .310
sp. 12 mm

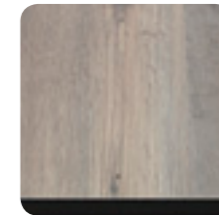

LEGNO .311
sp. 12 mm

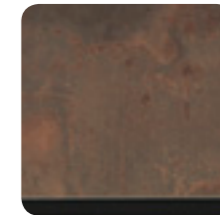

CORTEN .312
sp. 12 mm



CAFFÈ .302
sp. 12 mm



ANTRACITE .303
sp. 12 mm



AGAVE .316
sp. 10 mm

laminato HPL Solid Core

Laminato decorativo ad alta pressione, compatto, omogeneo, non poroso, ad alta densità. Decorative high pressure laminate, solid, homogeneous, non-porous and with a high density. Stratifié décoratif à haute pression, condensé, homogène, pas poreux, haute densité. HPL-Laminat, beständig, homogen, hoch verdichtet. Laminado decorado a alta presión, compacto, homogéneo, no poroso y de alta densidad.

Decorativo e laminado a alta pressão, sólido, homogêneo, não poroso e de grande densidade. Dekoratif yüksek basınçlı laminat, masif, gözeneksiz ve yüksek yoğunluklu. Декоративный ламинат высокого давления, компактный, однородный, непористый, с высокой плотностью.



TOTAL WHITE .314
sp. 10 mm

Fenix NTM®/Solid



NERO FENIX NTM® .313
sp. 10 mm

vetro

Vetro float temperato serigrafato e vetrificato a 700°C. Spessore 10 mm.
Tempered Float glass, screen-printed and vitrified at 700° C. 10 mm thick.
Verre float trempé sérigraphié et vitrifié à 700°C. Epaisseur 10 mm.
Sicherheitsglas mit innenliegendem Dekorsiebdruck, verglast bei 700°. Dicke 10 mm.

Vidrio float, templado, serigrafiado y vetrificado a 700°C. Espesor 10 mm.
Vidro float temperado, impresso e vitrificado a 700°C. Espessura 10 mm.
Temperli, üstü baskılı ve 700° C vitrifiye edilmiş. Kalınlık 10 mm.
Сериграфированное закаленное стекло float, производимое при 700°C. Толщина 10 мм.



BIANCO .00



ANTRACITE .02

vetro

Vetro extrachiaro temperato. Spessore 6 mm.
Extra-clear tempered glass. 6 mm thick.
Verre trempé extra clair. Epaisseur 6 mm.
Extra klares gehärtetes Glas. Dicke 6 mm.

Vidrio templado extra claro. Espesor 6 mm.
Vidro temperado extra claro. Espessura 6 mm.
Ekstra net temperli cam. Kalınlık 6 mm.
Особо прозрачное закаленное стекло. Толщина 6 мм.



vetro .501



impilabile stackable empilable stapelbar apilable empilhável istiflenebilir стекируемые



impilabile orizzontalmente stackable horizontally piètement encastrable lneinander stapelbar apilable horizontalmente empilhável horizontalmente yatay olarak istiflenebilir горизонтальная расстановка



pieghevole folding pliant klappbar plegable dobrável katlanabilir складывающийся



reclinabile reclining dossier réglable verstellbare Rückenlehne reclinable reclinável sırt pozisyonlu откидной

Tutte le sedute sono dotate di piedini antiscivolo. All chairs are equipped with non-slip feet. Tous les sièges sont équipés avec patins anti-dérapants. Alle Stühle sind mit rutschfesten Fußkappen ausgestattet. Todos los asientos están equipados con tapones antideslizantes. Todos os assentos estão equipados com pés antiderrapantes. Bütün sandalyeler kaymaz ayaklıdırlar. Ножки всех стульев оснащены противоскользящей резиновой подложкой.

Sui colori scuri, ombre ed altri difetti minori sono più evidenti rispetto ai colori chiari e sono da ritenersi standard. On dark colors, shadows and other minor faults are more evident than on lighter colors and are therefore standard. Sur les couleurs sombres, les ombres et les autres petits défauts sont plus marqués que sur les couleurs claires et sont tout à fait standards. Auf dunklen Farben sind Schatten und andere kleinere Mängel sichtbar als auf hellen Farben und sind daher als Standard zu betrachten. Las sombras y demás defectos menores son más evidentes sobre los colores oscuros respecto a los colores claros y tienen que considerarse como estándares. Em cores escuras, sombras e outros defeitos menores são mais evidentes do que em cores claras e devem ser considerados standard. Koyu renkler üzerinde, gölgeler ve diğer küçük defolar açık renkler üzerinde olduklarından daha belirginleşmekte ve bu nedenle normal olarak değerlendirilmelidirler. По сравнению со светлыми цветами на темных цветах тени и другие небольшие дефекты более заметны и должны считаться нормой.

Il peso (kg), le misure (cm) e i colori riportati sono indicativi. La NARDI si riserva il diritto di apportare modifiche o varianti senza preavviso. Tutti i modelli sono depositati. Weights (kg), dimensions (cm) and colors are indicative only. NARDI reserves the right to make changes or variations without notice. All models are patented. Le poids (kg), les dimensions (cm) et les coloris indiqués sont fournis purement à titre indicatif. La Firma NARDI se réserve le droit d'apporter toute modification ou variation sans aucun préavis. Tous les modèles sont déposés. Alle Farb-, Maß- (cm) und Gewichtsangaben (kg) sind nicht als fest bindend anzusehen Firma NARDI behält sich das Recht von Änderungen Alle Modelle sind gesetzlich geschützt. El peso (kg), las medidas (cm) y los colores detallados, son indicativos. La firma NARDI se reserva el derecho de modificaciones o variaciones sin previo aviso. Todos los modelos llevan nuestra marca. O peso (kg), as medidas (cm) e as cores indicadas, são indicativos. A NARDI reservase o direito de aportar modificações ou variações sem pré-aviso. Todos os modelos estão depositados. Ağırlık (Kg), boyutlar (cm) ve renkler gösterme amaçlıdır. NARDI'nin önceden bildirmeden değişiklik yapma hakkı vardır. Bütün modeller patentlidir. Приведенный вес (кг), размеры (см) и цвета являются ориентировочными. Компания NARDI оставляет за собой права вносить изменения и вариации без предварительного предупреждения. Все модели зарегистрированы.

NARDI s.p.a.
Chiampo (VI) Italy
tel. +39 0444 422100
info@nardioutdoor.com
www.nardioutdoor.com



10101107